



# GRINDMASTER™

C O R P O R A T I O N

## Model 3312 Beverage Freezer Manual



Grindmaster Corporation

**Parts And Service**

[www.frozendrinkmadness.com](http://www.frozendrinkmadness.com)

972-276-2757, Fax 972-423-9993

[Randy@frozendrinkmadness.com](mailto:Randy@frozendrinkmadness.com)

[www.MargaritaMachineParts.Net](http://www.MargaritaMachineParts.Net)





# Table of Contents

<b>Safety Precautions .....</b>	<b>2</b>
<b>Freezer Applications &amp; Specifications .....</b>	<b>2 - 3</b>
<b>Installation .....</b>	<b>4 - 6</b>
<b>Operation and Adjustments .....</b>	<b>6 - 7</b>
<b>Care &amp; Cleaning .....</b>	<b>8 - 11</b>
<b>Maintenance .....</b>	<b>11 - 13</b>
<b>Troubleshooting .....</b>	<b>14</b>
<b>Key Parts Identification .....</b>	<b>15</b>
<b>Assembly Diagrams .....</b>	<b>16 - 21</b>
<b>Wiring Diagrams .....</b>	<b>22 - 27</b>
<b>Refrigeration Diagrams .....</b>	<b>29 - 30</b>

Information contained within this manual is subject to change without notice.

Contact Grindmaster Corporation's Customer/Technical Service Department at 1-800-695-4500 with any questions or for clarification.

## OPERATOR'S SAFETY PRECAUTIONS

**IMPORTANT:** Failure to comply with the following safety precautions may result in severe personal injury or damage to the machine.

1. Read and understand the operating instructions in this manual thoroughly. Only allow properly trained persons to operate this machine.
2. Note all warning labels on the freezer. If any warning labels are missing or damaged replace them immediately.
3. Do not wear loose fitting garments or jewelry which could cause a serious accident.
4. Stay alert at all times during operation.
5. Keep operating area clean.
6. Do not attempt any repairs unless the main power supply to the freezer has been disconnected. Contact Grindmaster Technical Service for service assistance.
7. Do not put objects or fingers in the dispense plunger.
8. Do not operate freezer if any excessive noise or vibration occurs. Contact your authorized service agent.
9. Be certain machine is installed with adequate space for proper air circulation. (See installation section.) Failure to provide sufficient ventilation will reduce freezer performance and void equipment warranty.



Located on the right, left and rear panels. (part # W0600218)

## FREEZER APPLICATION AND SPECIFICATIONS

### Model 3312

The freezer consists of two freezing cylinders with rotating internal augers (dashers) that are belt-driven by electric motors. The augers scrape frozen product off of the inside of the refrigerated cylinders. Torque sensing mechanisms control compressor operation to maintain desired product consistency. The freezer utilizes an air-cooled refrigeration system to freeze the product. Self-closing dispensing valves are attached to the front of the freezing cylinder. The unit has an adjustable consistency control and an out of product indicator for each side.

When properly operated and cared for, the Model 3312 will provide many years of service. Proper care includes regular cleaning and maintenance. To minimize the amount of maintenance necessary, follow the operating procedures outlined in this manual.

### Product Tips

The Model 3312 was designed to dispense a wide variety of frozen beverages including frozen fruit juice, frozen lemonade, slush and frozen cocktails. These products can be served in consistencies ranging from thin to fairly thick.

Two types of dispensing valve plungers and product consistency springs are available depending on the thickness of the product being served. These parts are interchangeable depending upon your needs. One plunger, part W0480438 has one horizontal outlet slot and is used to serve thin to medium products such as frozen lemonade and slush. The other plunger, part W0480451 has two horizontal outlet slots and is used to serve thicker product such as neutral base frozen cocktails. A red spring, part W0631239, is used on the drive motor to adjust product consistency to serve thin to medium products. The yellow spring, part W0631238, is used for thicker product. The spring is located next to the drive motor behind the right hand side panel.

Over an extended period of time, some products, such as frozen cocktails that contain alcohol, have a tendency to separate, or stratify. Separation of product on the mix storage hopper can result in frozen product quality inconsistency. Simply keeping the product, in the mix storage hopper, stirred on a regular basis will eliminate this problem.

**Product Tips (cont.)**

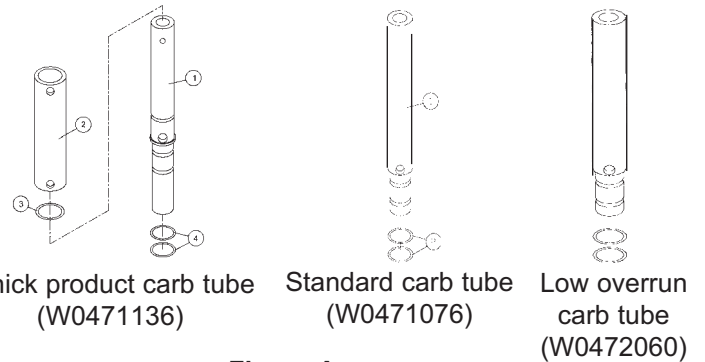
Some cappuccino or latté mixes contain dairy products which can spoil if not refrigerated. If the freezer is to be turned off at night these products must be removed from the freezer.

**Contact your local health department regarding its regulations for proper mix handling and storage.**

**Carburetor Assembly**

Your new freezer uses a metering device, known as a carburetor, to feed the proper ratio of mix and air into the freezing cylinder (and to prevent frozen product from rinsing out of the freezing cylinder).

The carburetor, or carb tube, is a tube with a hole, or series of holes, bored through the side. It is located in the hopper and fits in the hole that leads to the freezing cylinder. Air flows into the freezing cylinder through the top of the tube and mix flows in through a smaller hole in the side of the carb tube. The size of the mix inlet hole can be balanced with the viscosity (thickness) of the liquid mix and product draw rate, in such a way that the proper amount of mix is fed into the freezer cylinder to blend with air at just the right ratio. Mix viscosity varies by mix type, mix temperature and mix age. Different serving rates also demand different feed rates. For many products, the proper mix to air ratio is generally accepted to be two parts mix to one part air. This proportion yields a finished product that is both tasty and profitable. At this ratio, one gallon of liquid mix will yield a volume of one and one-half gallons of frozen product. This additional volume is the overrun in the product. Crathco offers three versions of carb tubes (see Figure A). Depending on the product being served and overrun requirements there is a standard tube for most slush or cocktail products, a low overrun carb tube that allows all air trapped in the freezing cylinder to escape and a smoothie/shake carb tube.



**Figure A**

This carb tube has an outer sleeve that can be rotated to line up with different hole sizes to provide various levels of overrun. *Most applications only require the standard carb tube.*

**Mix Considerations - General**

Freezing characteristics are affected by the amount of sweeteners and solids in the mix. The amount of sweeteners and solids is called BRIX. BRIX can be measured with an instrument called a refractometer. A BRIX reading of between 11 and 14 will provide optimum freezer operation. Mixes with this BRIX level will freeze down to a smooth, uniform consistency. Mixes with too high a BRIX level will take longer to freeze down and will yield a soft, wet frozen product. Mixes with too low a BRIX level will have larger ice crystals and will have a tendency to dispense slowly. Alcohol content also affects product freezing characteristics. High alcohol content may prevent the freezer from serving product at proper thickness.

**Note:** Always take BRIX measurement using mix that has been thoroughly blended, before it is frozen. Always allow frozen mix to thaw thoroughly before taking a reading.

For maximum output capacity, always pre-chill mix before adding it to the freezer. Pre-chilled mix gives the freezer a head start on the freezing process and will speed both initial freeze down and recovery time. It is normal for output capacity to decrease when warm mix is added, or when the freezer is operated in a warm area.

**Freezer Specifications**

	Standard 3312	CE 3312
<b>Dimensions (H x W x D)</b>	26-3/4"H x 18-1/2"W x 29"D 68 cm x 47 cm x 74 cm <i>(includes header box)</i>	26-3/4"H x 18-1/2"W x 29"D 68 cm x 47 cm x 74 cm <i>(includes header box)</i>
<b>Electrical</b>	115V / 60Hz / 1 PH Dedicated 20 Amp circuit	220-240V / 50 Hz / 1 PH Dedicated 15 Amp circuit
<b>Circuit NEMA #</b>	5-20R	Plugless cord (user must attach plug)
<b>Drive Motor</b>	1/2 hp, Capacitor Start	1/4 hp, Capacitor Start
<b>Compressor</b>	3/4 hp	3/4 hp
<b>Cooling</b>	Air-cooled	Air-cooled
<b>Actual Weight</b>	245 lbs (111 kg)	245 lbs (111 kg)
<b>Mix Hopper Capacity</b>	3 gallons (11.4 liters)	3 gallons (11.4 liters)
<b>Freezing Cylinder Capacity</b>	(2) 1-1/2 gallons (5.7 liters)	(2) 1-1/2 gallons (5.7 liters)
<b>Refrigerant</b>	See Serial Number Plate	See Serial Number Plate
<b>Refrigerant Charge</b>	See Serial Number Plate	See Serial Number Plate
<b>High Side (operating pressure / design pressure)</b>	Approx. 275-350 psi	Approx. 275-350 psi
<b>Low Side</b>	35-40 psi	35-40 psi

# INSTALLATION

## Shipment Transit

1. The freezer has been operated and tested at the factory. Upon arrival the complete freezer must be thoroughly checked for any damage which may have occurred in transit.

**Note:** A Tip (N) Tell warning device is placed on each shipping carton at the factory. If the indicator is red, the carton has been tipped in transit. (See Figure B)

2. **THE CARRIER IS RESPONSIBLE FOR ALL DAMAGE IN TRANSIT WHETHER VISIBLE OR CONCEALED. DO NOT PAY THE FREIGHT BILL** until the freezer has been checked for damage. Have the carrier note any visible damage on the freight bill. If concealed damage and/or shortages are found later, advise the carrier within 10 days and request inspection. The customer must place any claim for damage and/or shortage with the carrier. Grindmaster cannot make any claims against the carrier.



Figure B

## Installing Your Unit

1. Place the self-sealing rubber pad (shipped with the freezer) on a level counter that is stable and strong enough to safely support the freezer's weight (245 lbs / 111 kg), or if equipped with legs instead of pad, install legs by screwing them into the four leg holes on the bottom of the unit. (Leg Kit Part # W0890220 (4) 4" Legs)

2. Make sure freezer is to be placed in a location that is within 6' of a properly grounded circuit and allows adequate space at each side and above for proper air circulation.

**Air Cooled Units Only:** Minimum clearance is 6" (15 cm) on both sides and 0" at back and open above the freezer. (See Figure C)

**NOTE: Failure to allow adequate ventilation will void the warranty and reduce freezer performance.**

**NOTE: Locating the unit in high ambient temperatures (over 100°F / 37.8°C) will significantly reduce the performance of your machine.**

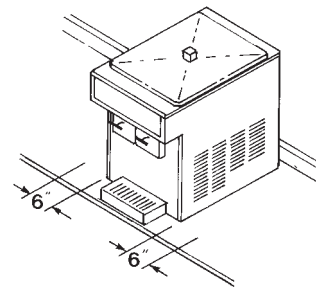




Figure C

3. Remove the side panels and supporting all four sides, lift machine up (by the frame) and place in appropriate area on top of rubber pad.

 **CAUTION: If equipped with spinner do not lift unit up by spinner shaft. It will cause serious damage to spinner.**

 **CAUTION: Beverage freezers are heavy pieces of equipment. It is recommended that moving or lifting the unit be done by two people to avoid injury.**

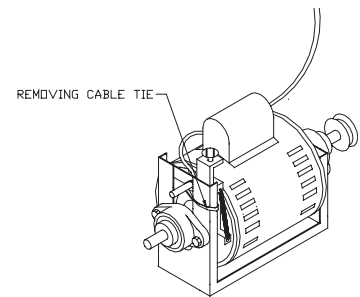


Figure D

4. The side panels should still be removed. Cut the cable tie on each motor used to secure motor during shipment. Make sure motors rock freely. (Figure D)

5. **220V/50Hz Units:** These units come with a plugless cord that requires the appropriate plug configuration be connected. This must be determined by the power outlets at the specified location. See wiring diagram at back of manual for assistance. It is recommended that a service technician performs this operation.

## Installing Your Unit (cont.)

6. Review hopper contents to make sure all parts are available:

Part #	Description
W0600170	Manual
W0600073	Rubber Pad Sheet
W0600121	Merchandiser Installation Sheet
W0600012	MSDS Sanitizer Sheet
W0600159	Warranty Registration Card
W0890182	Drip Tray Kit
W0520093	Hopper Cover
W0480445	Valve Handle
W0631230	Valve Spring
*	Carb Tube
*	Dispense Valve Plunger
W0470076	Lubricant
W0631903	Sanitizer Packets
W0600058	Laminated Cleaning Instructions
W0600327	Seal Installation Instructions

\* Optional items specified when the unit is ordered.

7. Fill out Warranty Registration Card with the requested information and mail to Grindmaster Corporation.
8. Replace side panels.
9. Assemble the dispense valve following the instructions on page 8. The valve plunger, spring and retaining pin come in the small parts bag.
10. Be sure ON-OFF-CLEAN switches (toggle switch located underneath the electrical box) are in the "OFF" position.
11. Connect the power cord directly to a properly grounded DEDICATED 120V/60Hz, 20 Amp circuit or 220-240V/50Hz, 15 Amp circuit for CE models. Do not use an extension cord.



**Do not alter or deform the plug in any way! Altering or deforming the plug may damage unit and will void warranty.**

12. Remove the drip tray kit from the bubble wrap. Separate the parts and remove the protective coating. The drip tray is mounted on two screws that are located on the lower front of the freezer cabinet.
13. Place the key hole slot of the drip tray support bracket on to these screws and tighten the screws.
14. Angle the back of the drip tray surround bracket into the drip tray support bracket and lower bracket to lock it into place.
15. Place drip tray onto drip tray surround bracket.
16. Place the louvered drip tray insert into drip tray.

## Accessory Installation

The Model 3312 has several optional accessories that can be added to the unit in the field to meet your application's needs. These accessories come with installation instructions.

- **Spinner** - Spinners are typically used in applications that add flavoring to a frozen neutral base product after it is dispensed. Allows operator to serve a wider variety of frozen drinks from one machine (i.e. hazelnut added to cappuccino). See Figure E.
- **Concealed Air Filter** - Prevents dust from clogging the condenser. Ideal for applications near beaches. Helps maintain maximum air flow and optimum freezer performance. See Figure F. NSF approved. Part # W0890200 stainless steel; W0890208 black.
- **Exposed Air Filter** - Similar to concealed air filter. Not NSF approved. Part # W0890206. See Figure G.
- **Valve Lock Security Bracket** - Part # W0471135. Ideal for self-service locations to prevent unauthorized use. Lock must be purchased separately. See Figure H.
- **Remote Fill Control** - Automatically refill the mix storage hopper. Provide additional labor savings by pre-mixing product automatically and monitoring system to maintain the mix hopper level.
- **Private Label Header** - A private label or different drink header can be installed by removing two screws from the electrical box cover. Place the header (transparency) between the clear and opaque plates (plastic lens). Put these in place under the lip of the machine top. Slip the electrical box cover back on to the machine and reinsert the screws. (See Figure I) Grindmaster offers a variety of drink headers including: frozen beverage, frozen lemonade, cappuccino, margarita, pina colada, frozen cocktail, frozen daiquiri and smoothie.

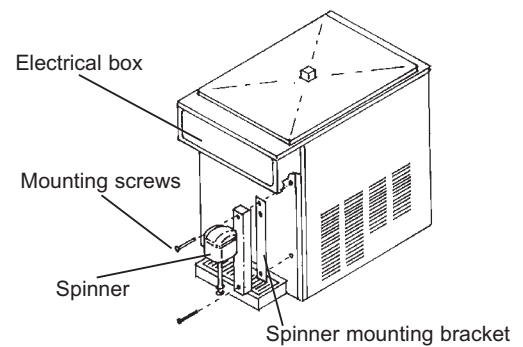


Figure E

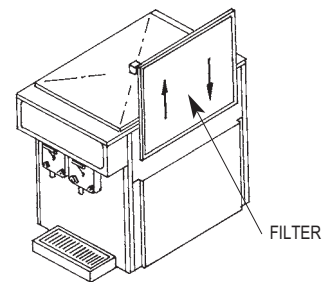


Figure F

SLIDE THE FILTER IN BEHIND THE FILTER PANEL, & IN FRONT OF THE EXISTING SIDE PANEL. TO CHANGE, REMOVE, CLEAN AND/OR REPLACE.

## OPERATION AND ADJUSTMENTS

### How to Operate

1. Sanitize unit following the cleaning instructions starting on page 8.
2. Fill the mix storage hoppers following the instructions on page 10. Allow barrels to fill with product to proper level, then insert carb tube from parts bag in hole toward rear of hopper. See Figure J.
3. Turn power switch to "ON" position for each barrel.
4. Allow product to freeze in barrel. Compressor will turn off when product in both barrels reaches pre-set consistency.
5. To dispense product pull down valve handle and release when done.
6. If product consistency is not as desired, adjust per the instructions on page 7.
7. Refill mix storage hopper when "mix out" light is ON.
8. Clean the unit regularly following local health codes.
9. Perform maintenance when necessary to increase the life of the unit. See chart in this manual for regular maintenance schedule.

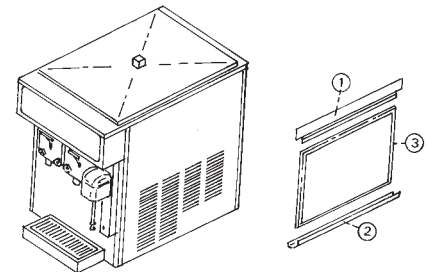


Figure G

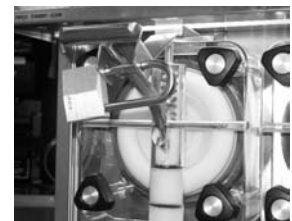


Figure H

### Mix Low Function

1. This model utilizes a simple float mechanism to sense when mix is low in hopper. (See Figure J) When the mix level in the hopper is low, the mix low light located in the front of the machine next to the valve block will illuminate. (The left-most light corresponds to the left barrel.)

**NOTE:** Do not run the unit under mix low conditions for long periods of time. This can affect machine performance or damage warranty.

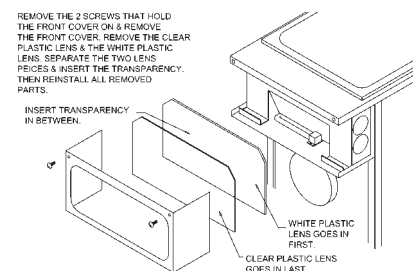



Figure I

## **Consistency Adjustment**

From time to time, it may become necessary to readjust the consistency setting (thickness) to compensate for variation between different mixes or to switch from one type of product to another. This adjustment is made as follows:

### **1. Disconnect electrical power.**

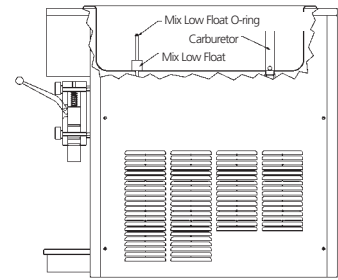
 **WARNING: Do not attempt to readjust the freezer until electrical power has been disconnected.**

2. Remove right side panel (facing the freezer).
3. Use the adjustment screw, situated on the front of the drive motor mounting bracket to change product thickness. Turn the thumbscrew (3 full turns for red spring, 1 turn for yellow spring) to make a noticeable change in consistency. (See Figure K)

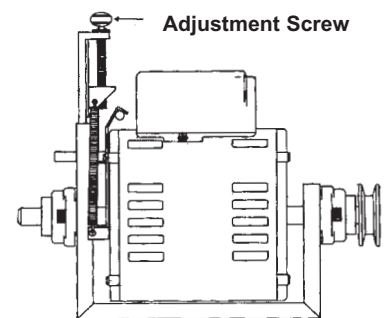
**NOTE:** Clockwise is for thicker product consistency and counter clockwise is for thinner product consistency. (See Figure L)

4. Reinstall the side panel, reconnect power.
5. Turn freezer to "ON" and allow it to freeze to desired consistency.
6. Check product. Repeat process until desired consistency is achieved.

**NOTE:** When making changes to a colder (thicker) setting, recheck consistency again after the compressor has cycled off. When adjusting (counter-clockwise) to a thinner consistency, a large portion of product should be drawn from the dispense valve to reduce the product thickness below the new set point (adjustment). Then allow the freezer to refreeze product to the new setting.

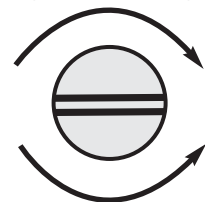


**Figure J**



**Figure K**

**Increase Thickness**  
(turn clockwise)



**Decrease Thickness**  
(turn counterclockwise)

**Figure L**

## CARE AND CLEANING

Cleaning and sanitizing frequency must be followed according to state and local health department regulations.

**NOTE:** Each time the freezer is fully disassembled, all foodzone freezer components must be thoroughly washed and sanitized using procedures recommended by the local health department. In lieu of local health department recommendations, use a three compartment sink; one compartment to wash parts in detergent, one compartment to rinse, and one to sanitize.

### Drain and Rinse

1. If the freezer is empty, proceed to Disassembly and Cleaning. If there is product in the freezer, turn either the right or left front panel switch to "CLEAN". Most users schedule cleaning when product in the hopper is low to minimize product loss.
2. On freezers using the optional Remote Fill Control and Proportioning Pump, turn "OFF" the water valve on the Proportioning Pump, using the valve next to the inlet pressure regulator and turn the switch on the Remote Fill Control to "OFF".
3. Open the front dispensing valve and drain all product from the freezer. Close the dispensing valve and turn freezer to "OFF".

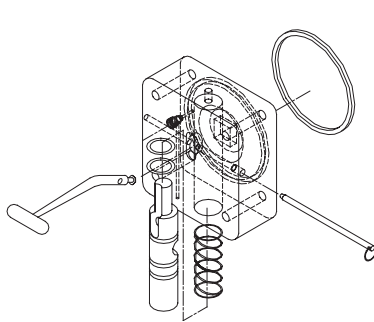
**NOTE:** Use approximately 2½ gallons (10 liters) of cool water to rinse product out of freezer.

4. Remove the carburetor tube and pour water into the storage hopper. Allow the water to fill the freezing cylinder.
5. Turn the panel switch to "CLEAN" for 5 minutes.
6. Open the dispensing valve and drain the water from the freezer.
7. Turn the freezer "OFF".

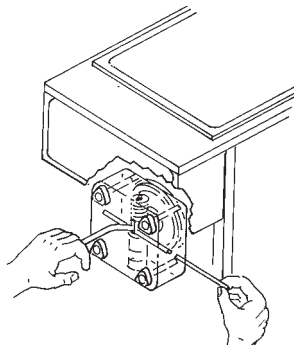
### Disassembly and Cleaning

**Note:** For cleaning and sanitizing before initial start-up remove carb tubes, dispense plungers, handles and springs from parts bag first.

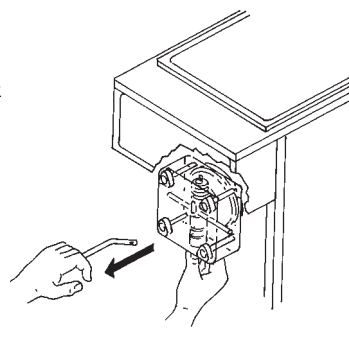
1. Disassemble the dispensing valve assembly (Figure M). Pull out valve handle retaining pin while supporting the valve plunger from the bottom (Figure N). Push up on the valve plunger and remove the stainless handle (Figure O). Slide the valve plunger and spring downward to remove (Figure P).
2. Remove knobs and carefully remove the front dispensing valve assembly, leaving the dasher assembly in the cylinder. Remove the o-rings from the plunger assembly and back of the dispensing valve body. (See Figure Q)



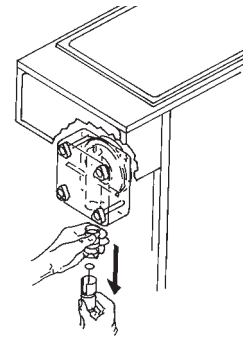
**Figure M** Disassemble Dispensing Valve



**Figure N** Remove Pin



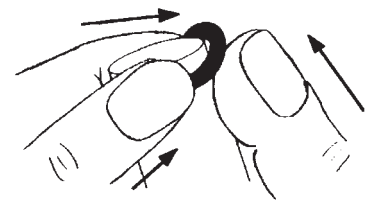
**Figure O** Remove Handle



**Figure P** Remove Plunger and Spring

**NOTE:** The best way to remove an o-ring is to first wipe off all of the lubricant using a clean paper towel. Pinch the o-ring upward with a dry paper towel between your index finger and thumb. When a loop is formed in the o-ring, roll it out of the groove with your other thumb. Always remove the o-ring farthest from the end of the plunger first. Carefully inspect the o-rings and replace if necessary. (See Figure Q)

3. Remove the dasher assembly from inside the freezing cylinder taking care to avoid damaging the rear seal assembly at the back of the freezing cylinder. Disassemble the dasher assembly by removing the stator rod and front and rear stator rod bearings.



**Figure Q** Ring Removal

### Disassembly and Cleaning (cont.)

- Remove stationary half of the shaft seal assembly from the back end of the freezer cylinder. This is accomplished by reaching into the cylinder and pulling seal out with your index finger. (See Figure R)
- Slide the rotary half of the seal off the dasher shaft. Inspect both seal components carefully for nicks or cracks. Replace seal if defective.

**NOTE:** To prevent leakage the surfaces of the rotary seal and the stationary seal must be smooth with no chips or cracks.

**NOTE:** All units are shipped with a standard ceramic seal (Part # W0340201) unless otherwise specified. Certain products contain coconut oil which requires a different sealing material. For these products use the coconut oil seal (Part # W0340210). The stationary half of the standard seal has a white polished surface. The stationary half of the coconut oil seal has a glossy black surface.

- Remove carb tube from bottom of hopper and remove o-rings. (See Figure S).
- Copy disassembly procedures on other side.
- Remove drip tray and empty contents.
- Take all components to the cleaning area.
- Prepare 1 gallon solution of hot tap water and a good grade of dishwashing detergent.
- Thoroughly wash all components in a warm, mild detergent solution including the inside of the freezing cylinder and the mix storage hopper. **DO NOT WASH COMPONENTS IN A DISHWASHER.**
- Use a medium sized brush to clean the bottom of the valve body and the inside of the plunger bore with detergent solution taking care to remove only remaining lubricant. (Figure T)
- The exterior of the freezer should be cleaned as needed with a cloth towel.



**CAUTION: Coarse rags, abrasive cleaners and excessive force can damage and/or scratch the surfaces of the freezer.**

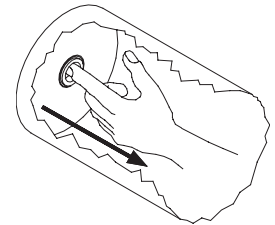
### Reassembly

**NOTE:** Allow all parts to dry completely before reassembly.

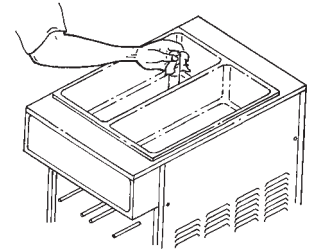
- Reassemble drip tray and re-install on front of unit.
  - Wet the inner rubber lip of the rotary half of the seal and the back end of the dasher shaft with water. Slide rotary half of assembly onto the dasher shaft, **RUBBER FIRST**, with the smooth sealing surface facing the back of the dasher. (See Figure U). Be sure the rotary half is fully seated against the shoulder of the shaft.
  - Insert the stationary half of the seal into the ribbed rubber boot with the polished surface facing out (forward).
  - Lightly lubricate the ribbed rubber boot of the stationary ceramic seal (taking care not to get any lubricant on the polished surface) and insert it straight back into the recess at the back of the freezing cylinder, **RUBBER FIRST**. (See Figure V)
- NOTE:** The stationary half of the seal must be completely dry before reassembling. If the circular half of the seal is white, make sure that the grooved side is toward the rubber. If the circular half is black, be sure the glossy side is facing out.
- Reassemble the dasher assembly, as shown in Figure W. Insert the larger front and smaller rear white plastic bearings into dasher, then slip in the stator rod.
  - Carefully and slowly guide the dasher into the freezing cylinder, taking care not to damage the seal assembly.** Turn dasher shaft until it engages the square drive coupling. Slide the dasher back into the cylinder so that the two smooth sealing surfaces meet. (See Figure X)
  - Inspect and lightly lubricate the large square o-ring and refit it into the back of the valve block assembly. Install the valve assembly on the front studs and tighten the knobs until they are finger tight. **Do not use tools to tighten knobs.**

**NOTE:** Failure to lightly lubricate the large o-ring can result in product leakage.

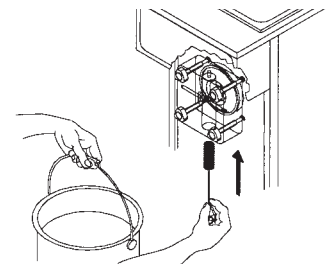
- Copy reassembly steps on other side.



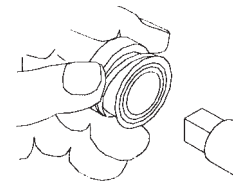
**Figure R** Installing the stationary half of seal



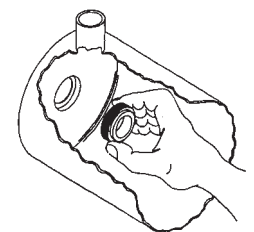
**Figure S** Carb Tube



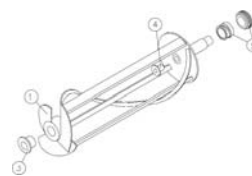
**Figure T** Clean Valve Body



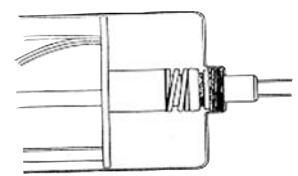
**Figure U** Re-assemble rotary half of seal as shown



**Figure V** Installing the stationary half seal



**Figure W** Dasher Assembly



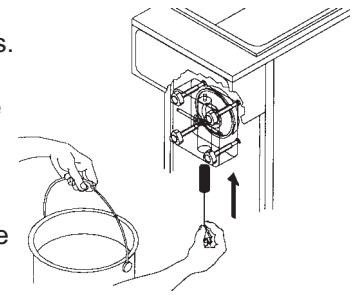
**Figure X** Seal Assembly

## **Sanitizing and Refilling**

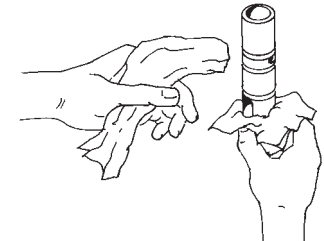
1. Reassemble carburetors by installing the two o-rings at the bottom of the carb tubes.
2. Place the carburetor assemblies in the bottom of each hopper.
3. Install the o-rings on each valve plunger and lay plunger assembly on a clean piece of paper towel.
4. Prepare a minimum of 2.5 gallons (9.5 liters) of sanitizing solution (Kay-5 Sanitizer/Cleaner or equivalent) following the manufacturer's instructions.

**NOTE:** Add 1 ounce of Kay-5 to 2.5 gallons (9.5 liters) of 120°F (50°C) water to achieve a concentration of 100 parts per million.

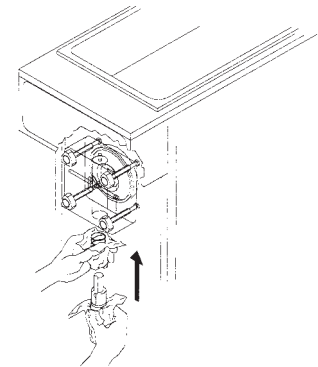
5. Dip a medium sized brush into the sanitizing solution and sanitize the inside bore of the dispensing valve. (Figure Y)
6. Place a small amount of lubricant onto a piece of clean paper toweling. Use a clean piece of paper toweling to pick up the small end of the valve plunger assembly. Apply a thin film of lubricant from the other piece of paper toweling. (Figure Z)
7. Slide the valve plunger spring over the small end of the valve plunger and, using another clean piece of paper toweling, pick up the valve plunger at the outlet end and insert plunger and spring into the valve body. (Figure AA)
8. Push up on the valve plunger and insert the stainless steel handle. (Figure BB)
9. Holding the handle down slightly so that the hole in the handle and valve block are aligned, insert the dispensing valve handle retaining pin. (Figure CC)
10. Repeat on other side.
11. Pour sanitizing solution into the mix storage hoppers and allow the solution to fill freezing cylinder. Use a large brush to sanitize all hopper surfaces. (Figure DD)
12. Turn panel switch on each side to "CLEAN" and allow freezer to run for 5 minutes.
13. Open dispensing valves and drain solution. Allow the dasher to push remaining sanitizer out of the freezing cylinders. Once the sanitizing solution is drained, turn panel switches to "OFF".
14. Place a small amount of sanitary lubricant onto another piece of clean paper toweling. Use a clean piece of paper toweling to pick up the large end of the carburetor from the bottom of the hopper taking care not to touch the sanitized carburetor with your bare hand (Figure EE). Apply the lubricant on the other piece of paper toweling to the two o-rings on the bottom of the carburetor assembly (Figure EE).
15. Place the lubricated carburetor assembly on a clean piece of paper toweling. Repeat with other carburetor assembly.
16. Prepare fresh product according to manufacturer's instructions.
17. Hold open the dispensing valve and pour product (approx. 10 oz.) into the hopper to allow this product to chase out any remaining sanitizer. Watch the product flowing out of the dispensing valve and close the valve when the new mix has purged the sanitizer remaining in the cylinder.
18. Use a clean piece of paper toweling to insert the sanitized carburetor assemblies into the inlet hole in each hopper.
19. Fill mix storage hopper with fresh product. Cover hopper with hopper lid.
20. Turn one front panel switch to "ON". Allow approximately 20 minutes for the freezer to reach proper consistency, then turn the other front panel switch "ON" to freeze down other side.



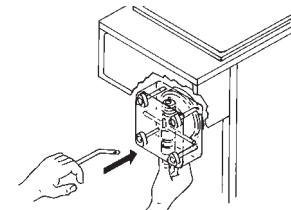
**Figure Y** Sanitize Valve Body



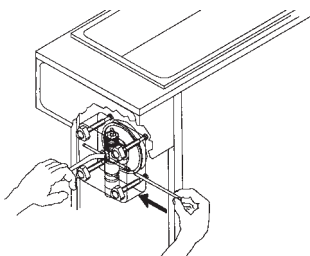
**Figure Z** Lubricate Plunger



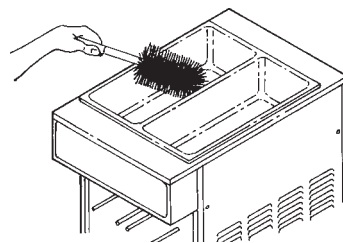
**Figure AA** Installing Plunger and Spring



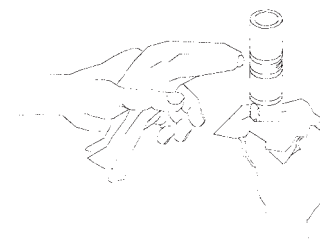
**Figure BB** Insert Valve Handle



**Figure CC** Insert Retaining Pin



**Figure DD** Sanitize Hopper



**Figure EE** Lubricate Carb Tube

### **Clean-In-Place Procedure (Daily Cleaning)**

This equipment has been approved for a Clean-In-Place procedure that does not require complete disassembly on a daily basis. The unit still requires regular complete disassembly for cleaning and sanitizing. To perform the C-I-P procedure follow the instruction below:

1. Empty any product in the machine and turn to OFF.
  2. Disassemble the dispensing valve assembly following the instructions in Disassembly and Cleaning.
- NOTE:** Leave the valve block in place. Only disassemble the plunger, handle, spring, o-rings and pin.
3. Remove carburetor assembly from hopper and remove o-rings.
  4. Take all components to the cleaning area.
  5. Carefully inspect the o-rings for cracks, chips or cuts and replace if necessary.
  6. Prepare 1 gallon solution of hot tap water and a good grade of dishwashing detergent.
  7. Thoroughly wash all parts including handle, pin, valve plunger, spring, carburetor assembly and all o-rings in detergent solution.
  8. Use a medium sized brush to clean the bottom of the valve body and the inside of the plunger bore with detergent solution taking care to remove any remaining lubricant.
  9. Reassemble following the instructions under Sanitizing and Refilling.
- NOTE:** Run the unit with sanitizer on "CLEAN" for 20 minutes before draining and refilling.
10. Repeat on other side.

## **MAINTENANCE**

 **WARNING: Disconnect power for maintenance. Do not attempt to perform maintenance on the freezer until electrical power has been disconnected.**

### **Suggested Daily Maintenance**

1. Clean, lubricate and sanitize the freezer following guidelines.
2. Clean the exterior of the freezer using a soft wet cloth. (Wipe down spinner if attached)
3. Empty drip tray.

### **Parts Replacement Schedule**

<b>Part Description</b>	<b>Monthly</b>	<b>Every 3 Months</b>	<b>Every 6 Months</b>	<b>Annually</b>	<b>Quantities to be Replaced</b>
Shaft Seal (W0340201 or W0340210)				Replace	1
Drive Shaft (W0451067)				Inspect & replace if necessary	1
Drive Belts (W0450209)				Inspect & replace if necessary	1
Scraper blades on dasher (if equipped) (W1431084)			Replace		2
Square cut o-ring on valve body/face plate (W0340055)				Inspect & replace if necessary	1
Front stator flange bearing (W0430032)				Replace	1
Rear stator flange bearing (W0430024)				Replace	1
Dispense valve o-rings (W0340022)		Replace			Thick Product Plunger: 2 Standard Product Plunger: 3
Carb tube o-rings (W0340011)		Replace			2 or 3
Condenser	Inspect & clean if necessary (Air-cooled units only)				1

Refer to the Crathco Parts Price List when ordering the above parts

## **Preventative Maintenance Procedure (Every 6 to 12 Months)**

A preventative maintenance visit should be performed every 6 to 12 months depending on the usage and environment where the unit is placed. (Ex. seasonal machines - once before season, year round machines - twice per year). The following procedures should be performed during a preventative maintenance visit. This does not take the place of daily care and cleaning procedures as described by local health codes and the manual. PM kit #W0890157 contains the standard replacement parts needed for preventative maintenance including o-rings, standard seal kit stator bearings and drive belt. One kit is required for each barrel receiving maintenance. Units with a coconut oil product seal should order all parts separately. Units with scraper blade dasher will require the scraper blades be ordered separately.

- Verify ventilation is adequate (Air-cooled units: 6" minimum on both sides, open at top, and as far as possible from dust sources; Water-cooled units: 0" on both sides, 3-6" at rear of unit and open at top).
- Verify adequate water flow and drain connections on water-cooled versions.
- Check product temperature and consistency for proper setting (refer to product manufacturer's recommendation) - adjust if necessary. Where equipped be sure to check the temperature in both the hopper and cylinder.
- Ensure product is being mixed properly and is within specification (check brix - most products should be around 13% - refer to product manufacturer's recommendations for exact recommended brix).
- Check for any leaks.
- Empty product from the unit. Disassemble unit completely (as if for cleaning).
- Clean and sanitize all disassembled parts following the cleaning instructions in the manual.
- Clean and sanitize hopper, freezing cylinder and splash zones on the machine.
- Check condition of all panels and lids - replace if necessary.
- Check dasher scraper blades for wear if equipped - replace once per year minimum.
- Check dasher for signs of wear - replace if necessary. Verify alignment when replacing.
- Check valve body gasket for wear - replace once per year minimum.
- Check valve body knobs (used to hold valve body in place) - replace if necessary.
- Check condition of shaft seals and stator bearings - replace once per year minimum.
- Inspect drip cup at back end of freezing cylinder for signs of seal leakage.
- Replace o-rings on hopper float (where necessary), dispense valves and carb tubes (lubricate).
- Lubricate parts where appropriate (dispense valve o-rings, carb tube o-rings, rubber boot of stationary shaft seal).
- Re-assemble unit and sanitize hopper and freezing cylinder by running CLEAN cycle.
- Clean and sanitize spinner if equipped.
- Check operation of merchandiser and mode lights - replace light bulbs if necessary.
- Clean reusable filter if equipped. Check condition of filter and replace if necessary.
- Clean condenser.
- Inspect the drive shaft and motor shaft bearings for excessive wear (drive shaft hole rounding out) - replace if necessary. Verify alignment when replacing.
- Check V-belt tension (should be 1/2" - 5/8") and verify all set screws are tightened - adjust if out of range. Replace belt once per year minimum.
- Verify compressor operation and freezer controller operation.
- Check electrical connections (outlet should be properly grounded with amperage capacity equal to or over the amperage specified on the serial tag).
- Check fan operation (condenser fan) and clean fan blades if necessary.
- Review proper periodic care and cleaning instructions (disassembly, cleaning, sanitizing, lubrication, and re-assembly) with store personnel. Train store personnel to follow proper procedures (stress importance of store level maintenance ie. lubrication, filter cleaning, etc.).
- Make sure store personnel have appropriate supplies (lubricant, cleaning brushes and sanitizer) to care for machine.

### How to Clean Condenser (Air-Cooled Unit Only)

**NOTE:** Loss of refrigeration efficiency will result if condenser is allowed to become dirty. Excessive compressor run time or loss of capacity are a good indication that the condenser needs to be cleaned.

1. **Disconnect electrical power.**
2. **Remove** side panels.
3. **Place a damp towel over the side of the condenser opposite the fan motor.**
4. Use compressed air or CO<sub>2</sub> blow out dirt from the fan side of the condenser. An alternate cleaning method is to use a condenser brush and vacuum cleaner.



**CAUTION:** Procedure can create a loud noise.

### How to Clean Exposed Filter (Air-Cooled Unit Only)

1. Slide exposed filter out of the rails by pulling forward on the filter. It is recommended to remove the filter by using the palm of your hand and applying even pressure to the face of the filter.
2. Clean filter with liquid soap and water.
3. Soak filter for 15 minutes.
4. Rinse filter with heavy stream of water, opposite the direction of air flow. Allow filter to dry.
5. Slide the filter into the rails until the filter contacts the stop on the top rail.

### How to Clean Concealed Filter (Air-Cooled Unit Only)

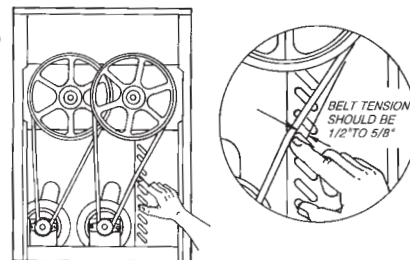
1. For concealed filters lift lid and pull up on filter tab to remove filter.
2. Clean filter with liquid soap and water.
3. Soak filter for 15 minutes.
4. Rinse filter with heavy stream of water, opposite the direction of air flow. Allow filter to dry.
5. Slide filter into top of filter cover with removal clip up and the air flow arrows facing the existing panel.

### How to Adjust Belt



**CAUTION:** Unplug the machine before performing any adjustments. This procedure must be done by a qualified technician.

Check the belt tension. The proper belt deflection is 1/2" over all. If the deflection is more than 1/2" the motor will need to be lowered. If the deflection is less than 1/2", the motor will need to be raised. Follow this procedure to adjust the motor to achieve proper belt tension. (See Figure FF)



**Figure FF**

1. Unplug the machine and remove both side and rear panels.
2. Locate the motor flange bearings. These are the side mounted bearings that hold the motor to the cradle. The motor is double shafted and the shaft extends through a bearing on each end. The bearing is held to the motor cradle by two allen bolts on each bearing.
3. Loosen the allen bolts on each bearing. Do not loosen the setscrews that hold the bearing collar to the motor shaft.
4. Lower the motor or raise the motor as needed. The motor must be kept level from front to back. Do not lower or raise only one end of the motor. This will result in excessive belt wear and belt noise.
5. Tighten all four allen bolts down. Align the motor pulley with the top pulley if needed.
6. The motor pulley should be in alignment with the large (driven) top pulley. Use a straight edge along the top pulley.
7. If the pulleys are not in alignment, loosen the setscrew on the motor pulley and move either in or out as needed.
8. Tighten the setscrew back down on the motor shaft (use of non-permanent loc-tite is recommended). Please be sure the setscrew is tightened down on the flat surface of the motor shaft.
9. Return the unit back to service.

### How to Change Back Lit Sign Merchandiser Bulb

1. Remove the two screws, located on the top of either side of the sign.
2. Lower the metal enclosure that frames the merchandiser insert.
3. Pull merchandiser enclosure down and out.
4. Replace bulb inside.
5. Reassemble. For ease of assembly, put merchandiser in light box before placing metal enclosure back on.

## GENERAL TROUBLESHOOTING

Freezer problems typically originate from three sources - improper operation, mix problems or mechanical malfunction. *Always check for improper operation and mix problems first, as they are the most common cause of most equipment problems.*



**CAUTION:** Always disconnect power before attempting any maintenance procedures.

**Only a qualified service technician should perform electrical and mechanical adjustments or repairs.**












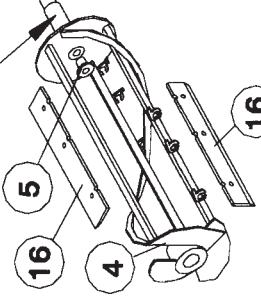

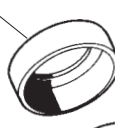









































































































































































PROBLEM	PROBABLE CAUSE	REMEDY
Machine will not run or freeze down	<ul style="list-style-type: none"> <li>Machine not plugged in</li> <li>Circuit breaker tripped or fuse blown</li> <li>Machine in CLEAN or OFF position</li> <li>Obstructed condenser air flow (Air-cooled units)</li> <li>Compressor not operating</li> <li>Dasher not installed</li> <li>Low refrigerant charge</li> </ul>	<ul style="list-style-type: none"> <li>Plug machine in</li> <li>Reset breaker or replace fuse</li> <li>Switch to ON position</li> <li>Clean condenser. Allow 6" (15 cm) on both sides</li> <li>Check for cause and correct</li> <li>Install dasher (auger)</li> <li>Check for leaks, repair and recharge</li> </ul>
Product too soft	<ul style="list-style-type: none"> <li>Consistency setting too loose</li> <li>Consistency setting at maximum (red spring)</li> <li>Product BRIX level too high</li> <li>Too much alcohol in mix</li> </ul>	<ul style="list-style-type: none"> <li>Readjust consistency control</li> <li>Change to yellow consistency spring</li> <li>Lower liquid product BRIX level</li> <li>Lower alcohol content</li> </ul>
Product too stiff	<ul style="list-style-type: none"> <li>Consistency adjuster set too firm</li> <li>Product BRIX level too low</li> </ul>	<ul style="list-style-type: none"> <li>Readjust consistency setting or change to red spring</li> <li>Increase product BRIX level</li> </ul>
Product will not dispense	<ul style="list-style-type: none"> <li>Power switch OFF</li> <li>Inadequate mix in hopper. Red MIX LOW light on</li> <li>Consistency adjuster set too firm</li> <li>Carburetor inlet hole clogged</li> <li>Drive belt broken or off pulley</li> <li>Drive shaft worn</li> <li>Drive motor failure</li> </ul>	<ul style="list-style-type: none"> <li>Turn power switch ON</li> <li>Refill hopper</li> <li>Readjust consistency setting</li> <li>Unclog carburetor inlet hole</li> <li>Repair or replace</li> <li>Inspect square drive shaft pocket for excessive wear, replace</li> <li>Replace motor</li> </ul>
Leakage from drain tube, front of freezer above drip tray	<ul style="list-style-type: none"> <li>Worn or defective shaft seal</li> <li>Seal installed incorrectly</li> </ul>	<ul style="list-style-type: none"> <li>Replace seal and then lubricate at each cleaning</li> <li>Remove and install seal</li> </ul>
Excessive Dispensing Valve Leaks	<ul style="list-style-type: none"> <li>Worn or defective o-ring(s)</li> </ul>	<ul style="list-style-type: none"> <li>Replace and lubricate</li> </ul>
Clicking sound from inside machine	<ul style="list-style-type: none"> <li>Low voltage</li> <li>Extension cord is used</li> </ul>	<ul style="list-style-type: none"> <li>Use dedicated circuit with proper rating</li> <li>Connect directly to power source or use power cord of proper size</li> </ul>
Thumping sound from inside machine	<ul style="list-style-type: none"> <li>Worn belt</li> </ul>	<ul style="list-style-type: none"> <li>Replace belt</li> </ul>
Scraping sound during freeze down	<ul style="list-style-type: none"> <li>Frozen product scraping off of cylinder walls</li> <li>No product in machine</li> </ul>	<ul style="list-style-type: none"> <li>Sound should go away when product is frozen to proper consistency</li> <li>Fill with product</li> </ul>
Premature seal wear	<ul style="list-style-type: none"> <li>Incorrect installation of dasher</li> <li>Improper drive shaft clearance</li> <li>Incorrect shaft alignment</li> </ul>	<ul style="list-style-type: none"> <li>Advise careful installation</li> <li>Adjust to proper</li> <li>Align shaft</li> </ul>
Merchandiser light flickers when freezer cycles	<ul style="list-style-type: none"> <li>Low voltage</li> </ul>	<ul style="list-style-type: none"> <li>Connect freezer to dedicated circuit with proper rating</li> </ul>

If you still need help, call our Service Department at (800) 695-4500 (USA & Canada only) or (502) 425-4776 (Monday through Friday 8am - 6pm EST) or an authorized service center in your area. Please have the model and serial number ready so that accurate information may be given. Prior authorization must be obtained from Grindmaster's Technical Services Department for all warranty claims.

# CHECK LIST

# PARTS IDENTIFICATION

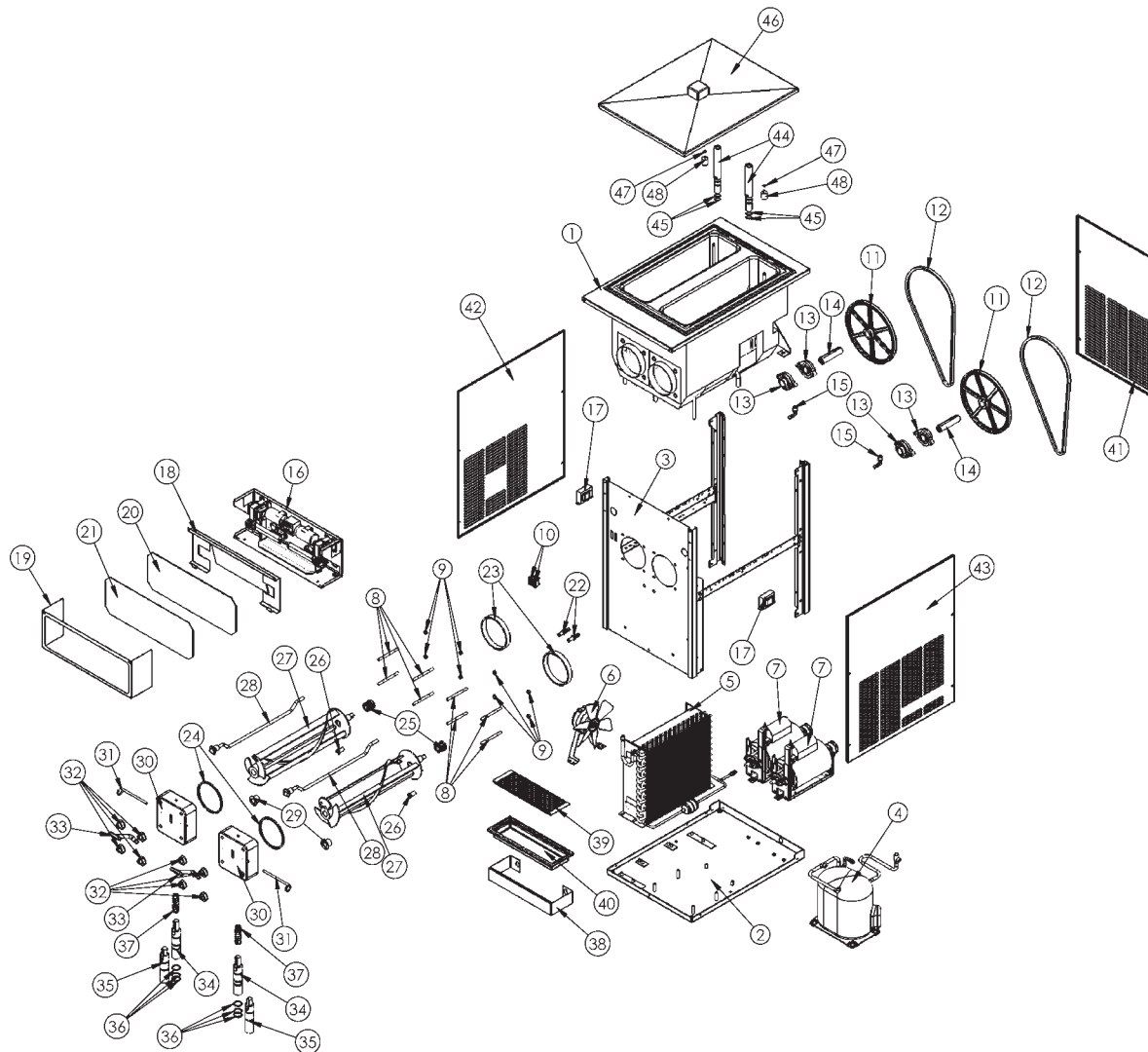
Do not cover ventilation grill on sides of machine.  
Read equipment instructions before handling parts.

<input type="checkbox"/>		1 Stationary Seal Rubber Part		12 Plunger O-Rings (W0340022)	<input type="checkbox"/>		18a Sleeve O-Ring (W0340012)
<input type="checkbox"/>		2 Stationary Seal Ring	<input type="checkbox"/>	13 Plunger Spring (W0631230)	<input type="checkbox"/>		18b Carburetor O-Rings (W0340011)
<input type="checkbox"/>		3 Spring Seal		14 Valve Pin (W0611728)	<input type="checkbox"/>		19 Optional Smoothie/ Shake Carburetor Sleeve. (W0471134)
Coconut Oil Seal (W0340210) and Standard Seal (W0340201) include 1, 2, & 3.							
<input type="checkbox"/>		4 Dasher (W0430026) Scrapers Blade Dasher (W0430089)	<input type="checkbox"/>	15 Valve Handle (W0480445)	<input type="checkbox"/>		Thin film of Lubricant.
<input type="checkbox"/>		5 Plastic Rear Bearing (W0430024)	<input type="checkbox"/>	16 Scraper Blade (W1431084) Use with scraper blade dasher	<input type="checkbox"/>		Optional Smoothie/Shake Carburetor comes together as a Kit, using Part numbers, 17b, 18a, 18b, & 19.
<input type="checkbox"/>		6 Plastic Front Bearing Standard (W0430032)	<input type="checkbox"/>	17a Standard Carburetor (W0471076)	<input type="checkbox"/>		Rough Side of Ceramic
<input type="checkbox"/>		7 Stator Rod (W0430028)	<input type="checkbox"/>	17b Optional Smoothie/ Shake Carburetor. (W0471128)	<input type="checkbox"/>		Smooth Shiny Side
<input type="checkbox"/>		8 Face Plate Quad Ring (W0340055)	<input type="checkbox"/>	14	<input type="checkbox"/>		= Lubricate
<input type="checkbox"/>		9 Valve Body (W0480450)	<input type="checkbox"/>	15	<input type="checkbox"/>	Assemble first, lubricate, then insert into freezing cylinder.	
<input type="checkbox"/>		10 Valve Knobs (W0630711)	<input type="checkbox"/>	16	<input type="checkbox"/>		11a Slush Plunger (W0480438)
<input type="checkbox"/>		11a Slush Plunger (W0480438)	<input type="checkbox"/>	17	<input type="checkbox"/>		11b Thick Product Plunger (W0480451)
<input type="checkbox"/>		11b Thick Product Plunger (W0480451)	<input type="checkbox"/>	18	<input type="checkbox"/>		17a
<input type="checkbox"/>		1	<input type="checkbox"/>	19	<input type="checkbox"/>		17b
<input type="checkbox"/>		2	<input type="checkbox"/>	20	<input type="checkbox"/>		18a
<input type="checkbox"/>		3	<input type="checkbox"/>	21	<input type="checkbox"/>		18b
<input type="checkbox"/>		4	<input type="checkbox"/>	22	<input type="checkbox"/>		17a
<input type="checkbox"/>		5	<input type="checkbox"/>	23	<input type="checkbox"/>		17b
<input type="checkbox"/>		6	<input type="checkbox"/>	24	<input type="checkbox"/>		18a
<input type="checkbox"/>		7	<input type="checkbox"/>	25	<input type="checkbox"/>		18b
<input type="checkbox"/>		8	<input type="checkbox"/>	26	<input type="checkbox"/>		17a
<input type="checkbox"/>		9	<input type="checkbox"/>	27	<input type="checkbox"/>		17b
<input type="checkbox"/>		10	<input type="checkbox"/>	28	<input type="checkbox"/>		18a
<input type="checkbox"/>		11	<input type="checkbox"/>	29	<input type="checkbox"/>		18b
<input type="checkbox"/>		12	<input type="checkbox"/>	30	<input type="checkbox"/>		17a
<input type="checkbox"/>		13	<input type="checkbox"/>	31	<input type="checkbox"/>		17b
<input type="checkbox"/>		14	<input type="checkbox"/>	32	<input type="checkbox"/>		18a
<input type="checkbox"/>		15	<input type="checkbox"/>	33	<input type="checkbox"/>		18b
<input type="checkbox"/>		16	<input type="checkbox"/>	34	<input type="checkbox"/>		17a
<input type="checkbox"/>		17	<input type="checkbox"/>	35	<input type="checkbox"/>		17b
<input type="checkbox"/>		18	<input type="checkbox"/>	36	<input type="checkbox"/>		18a
<input type="checkbox"/>		19	<input type="checkbox"/>	37	<input type="checkbox"/>		18b
<input type="checkbox"/>		20	<input type="checkbox"/>	38	<input type="checkbox"/>		17a
<input type="checkbox"/>		21	<input type="checkbox"/>	39	<input type="checkbox"/>		17b
<input type="checkbox"/>		22	<input type="checkbox"/>	40	<input type="checkbox"/>		18a
<input type="checkbox"/>		23	<input type="checkbox"/>	41	<input type="checkbox"/>		18b
<input type="checkbox"/>		24	<input type="checkbox"/>	42	<input type="checkbox"/>		17a
<input type="checkbox"/>		25	<input type="checkbox"/>	43	<input type="checkbox"/>		17b
<input type="checkbox"/>		26	<input type="checkbox"/>	44	<input type="checkbox"/>		18a
<input type="checkbox"/>		27	<input type="checkbox"/>	45	<input type="checkbox"/>		18b
<input type="checkbox"/>		28	<input type="checkbox"/>	46	<input type="checkbox"/>		17a
<input type="checkbox"/>		29	<input type="checkbox"/>	47	<input type="checkbox"/>		17b
<input type="checkbox"/>		30	<input type="checkbox"/>	48	<input type="checkbox"/>		18a
<input type="checkbox"/>		31	<input type="checkbox"/>	49	<input type="checkbox"/>		18b
<input type="checkbox"/>		32	<input type="checkbox"/>	50	<input type="checkbox"/>		17a
<input type="checkbox"/>		33	<input type="checkbox"/>	51	<input type="checkbox"/>		17b
<input type="checkbox"/>		34	<input type="checkbox"/>	52	<input type="checkbox"/>		18a
<input type="checkbox"/>		35	<input type="checkbox"/>	53	<input type="checkbox"/>		18b
<input type="checkbox"/>		36	<input type="checkbox"/>	54	<input type="checkbox"/>		17a
<input type="checkbox"/>		37	<input type="checkbox"/>	55	<input type="checkbox"/>		17b
<input type="checkbox"/>		38	<input type="checkbox"/>	56	<input type="checkbox"/>		18a
<input type="checkbox"/>		39	<input type="checkbox"/>	57	<input type="checkbox"/>		18b
<input type="checkbox"/>		40	<input type="checkbox"/>	58	<input type="checkbox"/>		17a
<input type="checkbox"/>		41	<input type="checkbox"/>	59	<input type="checkbox"/>		17b
<input type="checkbox"/>		42	<input type="checkbox"/>	60	<input type="checkbox"/>		18a
<input type="checkbox"/>		43	<input type="checkbox"/>	61	<input type="checkbox"/>		18b
<input type="checkbox"/>		44	<input type="checkbox"/>	62	<input type="checkbox"/>		17a
<input type="checkbox"/>		45	<input type="checkbox"/>	63	<input type="checkbox"/>		17b
<input type="checkbox"/>		46	<input type="checkbox"/>	64	<input type="checkbox"/>		18a
<input type="checkbox"/>		47	<input type="checkbox"/>	65	<input type="checkbox"/>		18b
<input type="checkbox"/>		48	<input type="checkbox"/>	66	<input type="checkbox"/>		17a
<input type="checkbox"/>		49	<input type="checkbox"/>	67	<input type="checkbox"/>		17b
<input type="checkbox"/>		50	<input type="checkbox"/>	68	<input type="checkbox"/>		18a
<input type="checkbox"/>		51	<input type="checkbox"/>	69	<input type="checkbox"/>		18b
<input type="checkbox"/>		52	<input type="checkbox"/>	70	<input type="checkbox"/>		17a
<input type="checkbox"/>		53	<input type="checkbox"/>	71	<input type="checkbox"/>		17b
<input type="checkbox"/>		54	<input type="checkbox"/>	72	<input type="checkbox"/>		18a
<input type="checkbox"/>		55	<input type="checkbox"/>	73	<input type="checkbox"/>		18b
<input type="checkbox"/>		56	<input type="checkbox"/>	74	<input type="checkbox"/>		17a
<input type="checkbox"/>		57	<input type="checkbox"/>	75	<input type="checkbox"/>		17b
<input type="checkbox"/>		58	<input type="checkbox"/>	76	<input type="checkbox"/>		18a
<input type="checkbox"/>		59	<input type="checkbox"/>	77	<input type="checkbox"/>		18b
<input type="checkbox"/>		60	<input type="checkbox"/>	78	<input type="checkbox"/>		17a
<input type="checkbox"/>		61	<input type="checkbox"/>	79	<input type="checkbox"/>		17b
<input type="checkbox"/>		62	<input type="checkbox"/>	80	<input type="checkbox"/>		18a
<input type="checkbox"/>		63	<input type="checkbox"/>	81	<input type="checkbox"/>		18b
<input type="checkbox"/>		64	<input type="checkbox"/>	82	<input type="checkbox"/>		17a
<input type="checkbox"/>		65	<input type="checkbox"/>	83	<input type="checkbox"/>		17b
<input type="checkbox"/>		66	<input type="checkbox"/>	84	<input type="checkbox"/>		18a
<input type="checkbox"/>		67	<input type="checkbox"/>	85	<input type="checkbox"/>		18b
<input type="checkbox"/>		68	<input type="checkbox"/>	86	<input type="checkbox"/>		17a
<input type="checkbox"/>		69	<input type="checkbox"/>	87	<input type="checkbox"/>		17b
<input type="checkbox"/>		70	<input type="checkbox"/>	88	<input type="checkbox"/>		18a
<input type="checkbox"/>		71	<input type="checkbox"/>	89	<input type="checkbox"/>		18b
<input type="checkbox"/>		72	<input type="checkbox"/>	90	<input type="checkbox"/>		17a
<input type="checkbox"/>		73	<input type="checkbox"/>	91	<input type="checkbox"/>		17b
<input type="checkbox"/>		74	<input type="checkbox"/>	92	<input type="checkbox"/>		18a
<input type="checkbox"/>		75	<input type="checkbox"/>	93	<input type="checkbox"/>		18b
<input type="checkbox"/>		76	<input type="checkbox"/>	94	<input type="checkbox"/>		17a
<input type="checkbox"/>		77	<input type="checkbox"/>	95	<input type="checkbox"/>		17b
<input type="checkbox"/>		78	<input type="checkbox"/>	96	<input type="checkbox"/>		18a
<input type="checkbox"/>		79	<input type="checkbox"/>	97	<input type="checkbox"/>		

# Model 3312

## Exploded View

### 115V Air-Cooled Model

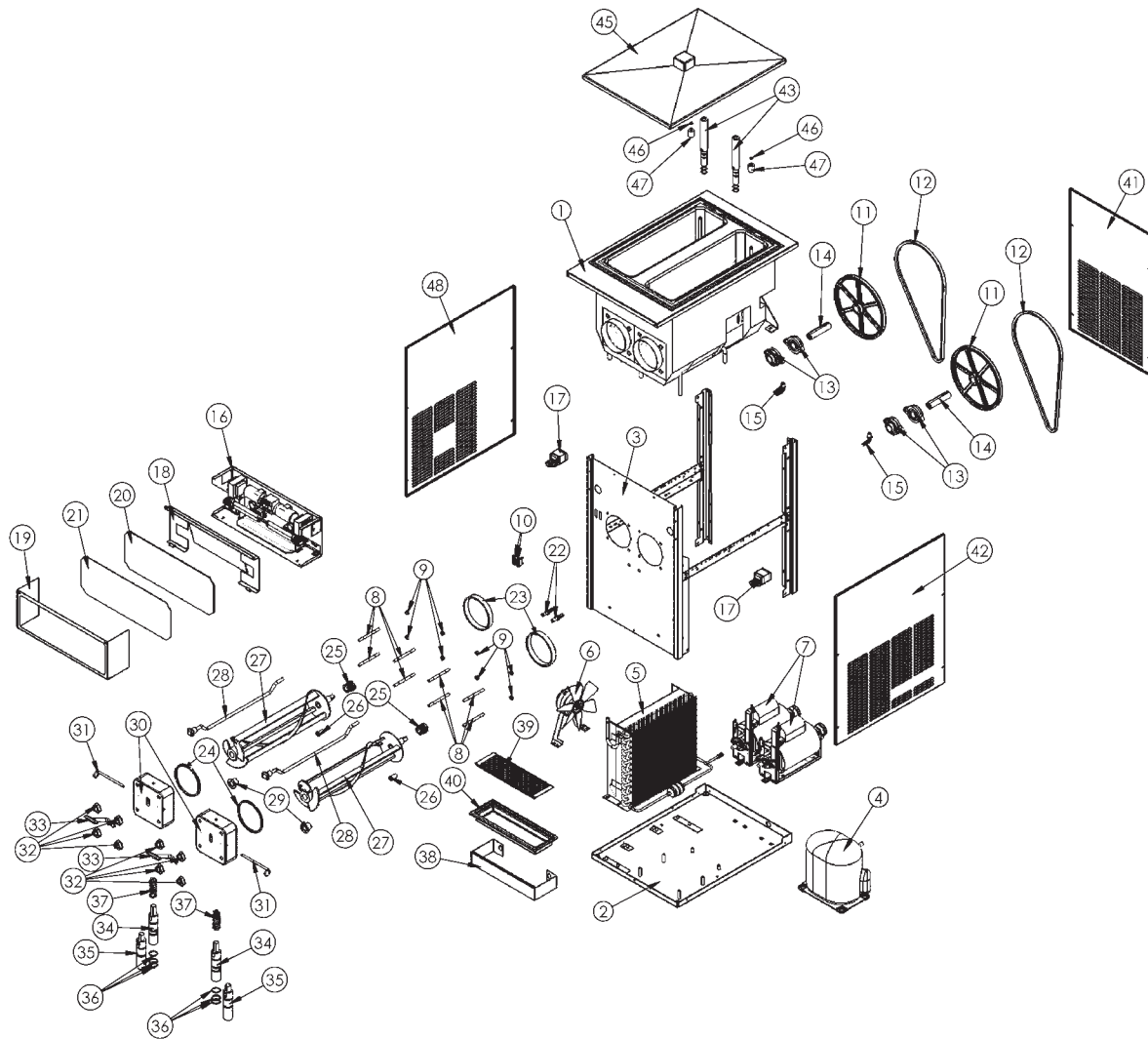


ITEM NO.	PART NO.	DESCRIPTION	ITEM NO.	PART NO.	DESCRIPTION
1	W0201302	Evaporator Assy 3312	26	W0430024	Rear Stator Bearing
2	W0210075	Base Pan Assy 3312	27	W0430026	Dasher, Standard
3	W0211210	Frame Assembly	28	W0430028	Stator Weldment Pickled
4	W0200806	Compressor Assembly 3312 115V	29	W0430032	Stator Flange Bearing
5	W0200807	Condenser Assembly, 3312	30	W0480450	Valve Body
6	W0321029	Fan Assembly, 115V	31	W0611728	FasPin, Valve
7	W0321035	Motor Assembly, 1/4 HP	32	W0630711	Valve Knob
8	W0110013	Stud, Valve New Style	33	W0480445	Valve Handle
9	W0611085	Nut, 5/16-18 S.S. Hex Nut	34	W0480438	Plunger, Std Prod, 3000 Series
10	W0570018	Light, Indicator Lt Red 12V	35	W0480451	Thick Product Plunger, 3000 Series
11	W0450053	Pulley, 10" W/ 1" Bore	36	W0340022	Plunger, O-Rings
12	W0450209	V-Belt 3L460 x 3/8" FHP	37	W0631230	Valve Spring
13	W0380025	Bearing, 1" Bore	38	W0471129	Drip Pan Bracket Twin
14	W0451067	Driveshaft, Slush	39	W0471130	Insert, Drip Pan 3312
15	W0620239	Elbow, 3/8 Barb X	40	W0631627	Pan, Drip Blk 3312/5312 Sm
16	W0572301	Elec. Box Assy 3312	41	W0520080	Rear Panel 3312
17	W0570045	Ballast	42	W0520081	L.H. Side Panel 3312
18	W0572307	Light Reflector, Twin	43	W0520082	R.H. Side Panel 3312
19	W0572383	Elec. Box Cover	44	W0471075	Carb Tube, Slush/Cocktail
20	W0631620	Front Display Lens 3312	45	W0340011	O-Ring, -115 Buna-N Carb Tube
21	W0631621	Front Display Lens Clear 3312	46	W0520093	Hopper Cover Twin
22	W0211112	Drain Tube Fitting	47	W0340007	#108 Float O-Ring
23	W0340058	Barrel Gasket	48	W0570941	Mix Low Indicator Float
24	W0340055	Valve Square Cut O-Ring			
25	W0340201	Shaft Seal Set			

# Model 3312

## Exploded View

### 220V Air-Cooled Model



ITEM NO.	PART NO.	DESCRIPTION
1	W0201302	Evaporator Assy 3312
2	W0210075	Base Pan Assy 3312
3	W0211210	Frame Assembly
4	W0200132	Compressor, AKA171AT032A4, 115V, 3PH, 60Hz
5	W0200807	Condenser Assembly, 3312
6	W0321040	Fan Assembly, 115V
7	W0321023	Motor Assembly, 1/4 HP
8	W0110013	Stud, Valve New Style
9	W0611085	Nut, 5/16-18 S.S. Hex Nut
10	W0570018	Light, Indicator Lt Red 12V
11	W0450053	Pulley, 10" W/ 1" Bore
12	W0450209	V-Belt 3L460 x 3/8" FHP
13	W0380025	Bearing, 1" Bore
14	W0451067	Driveshaft, Slush
15	W0620239	Elbow, 3/8 Barb X
16	W0572302	Elec. Box Assy 3312 220/50
17	W0570056	Ballast, 230V/50Hz
18	W0572307	Light Reflector, Twin
19	W0572383	Elec. Box Cover
20	W0631620	Front Display Lens 3312
21	W0631621	Front Display Lens Clear 3312
22	W0211112	Drain Tube Fitting
23	W0340058	Barrel Gasket
24	W0340055	Valve Square Cut O-Ring
25	W0340201	Shaft Seal Set

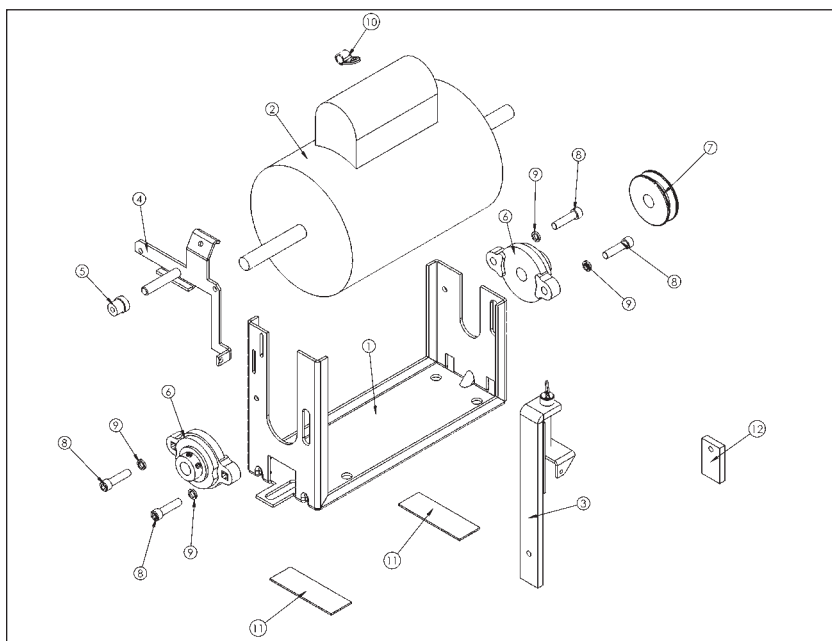
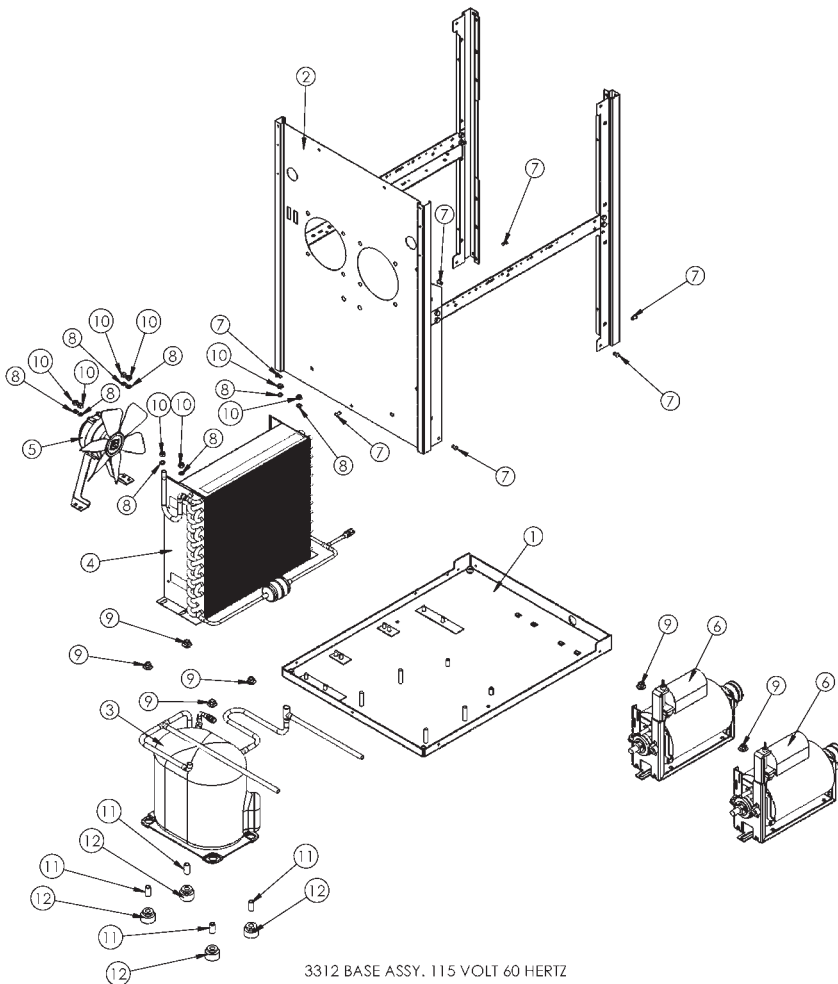
ITEM NO.	PART NO.	DESCRIPTION
26	W0430024	Rear Stator Bearing
27	W0430026	Dasher, Standard
28	W0430028	Stator Weldment Pickled
29	W0430032	Stator Flange Bearing
30	W0480450	Valve Body
31	W0611728	FasPin, Valve
32	W0630711	Valve Knob
33	W0480445	Valve Handle
34	W0480438	Plunger, Std Prod, 3000 Series
35	W0480451	Thick Product Plunger, 3000 Series
36	W0340022	Plunger, O-Rings
37	W0631230	Valve Spring
38	W0471129	Drip Pan Bracket Twin
39	W0471130	Insert, Drip Pan 3312
40	W0631627	Pan, Drip Blk 3312/5312 Sm
41	W0520080	Rear Panel 3312
42	W0520082	R.H. Side Panel 3312
43	W0471075	Carb Tube, Slush/Cocktail
44	W0340011	O-Ring, -115 Buna-N Carb Tube
45	W0520093	Hopper Cover Twin
46	W0340007	#108 Float O-Ring
47	W0570941	Mix Low Indicator Float
48	W0520081	L.H. Side Panel 3312

# Model 3312

## Base Assembly

### 115V Air-Cooled Model

Item	Part No.	Description
1	W0210075	Base Pan Assembly, 3312
2	W0211210	Frame Assembly
3	W0200806	Compressor Assembly
4	W0200807	Condenser Assembly
5	W0321029	Fan Assembly, 115V
6	W0321029	Motor Assembly, 1/4HP
7	W0611410	Rivet, Magna-Lok
8	W0611410	1/4 Int. Tooth Lk Washer
9	W0611082	Nut, 5/16-18 Flange, Lg
10	W0611074	Nut, Hex 1/4-20, Z/P
11	W0200412	Compressor Spacer
12	W0200413	Compressor Grommet



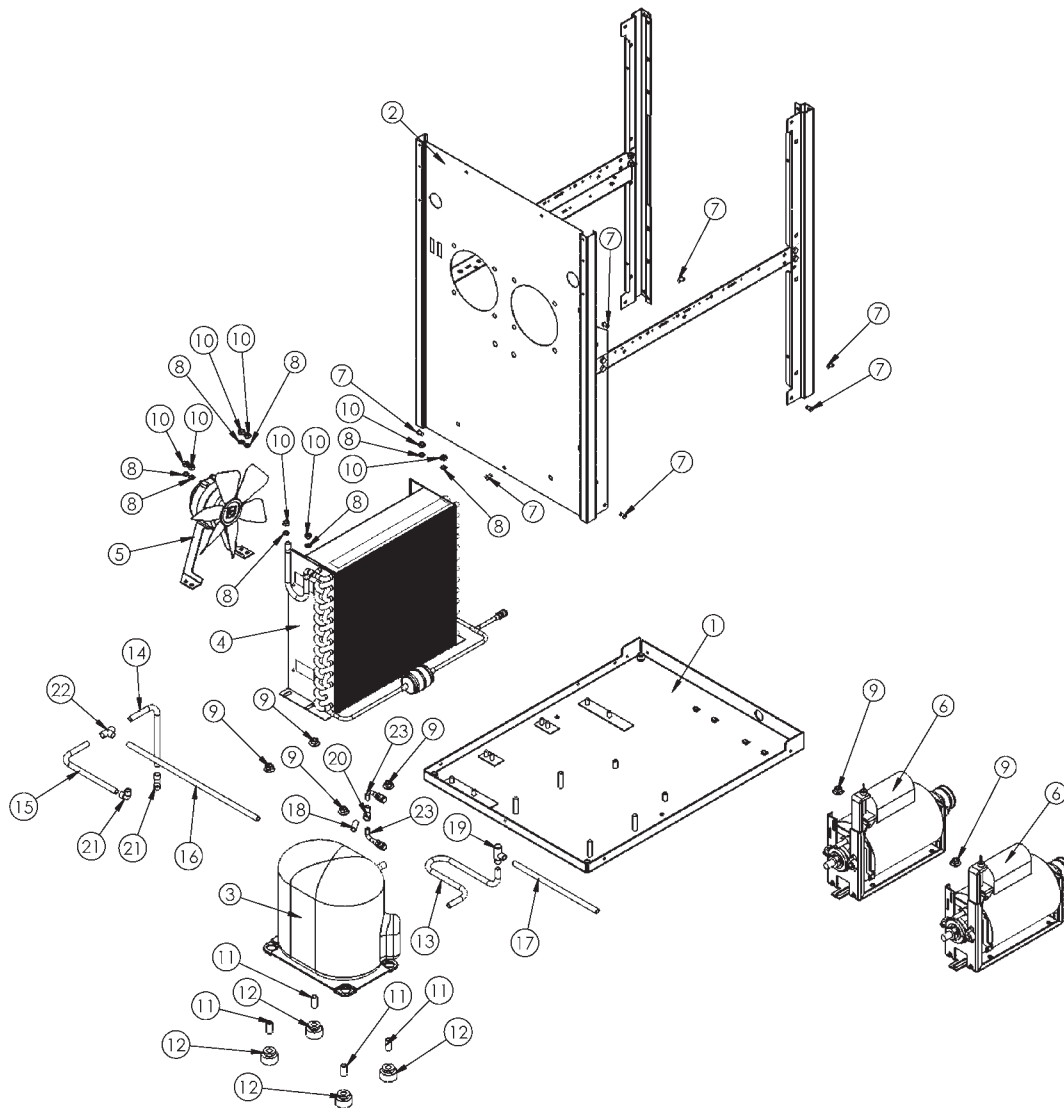
#### Drive Motor Assembly (See figure on left)

Item	Part No.	Description
1	W0210169	Motor Cradle
2	W0320019	Motor, Drive Dual Cycle 1/2 HP
3	W0170014	Consistency Control
4	W0321025	Motor Stop Bracket Assy
5	W0321027	Pin Sleeve
6	W0380009	Bearing, 1" Bore Flange
7	W0450016	Pulley, 0K7 x 1/2" Browning
8	W0610559	1/4-20 x 1 Socket Hd Cap Screw
9	W0611249	Washer, Split, Lock Z/P
10	W0630421	Cable Clamp
11	W0671022	Insulation, Motor Brkt Sound
12	W0321013	Nut, Motor Adjustment

# Model 3312

## Base Assembly

### 220V Air-Cooled Model

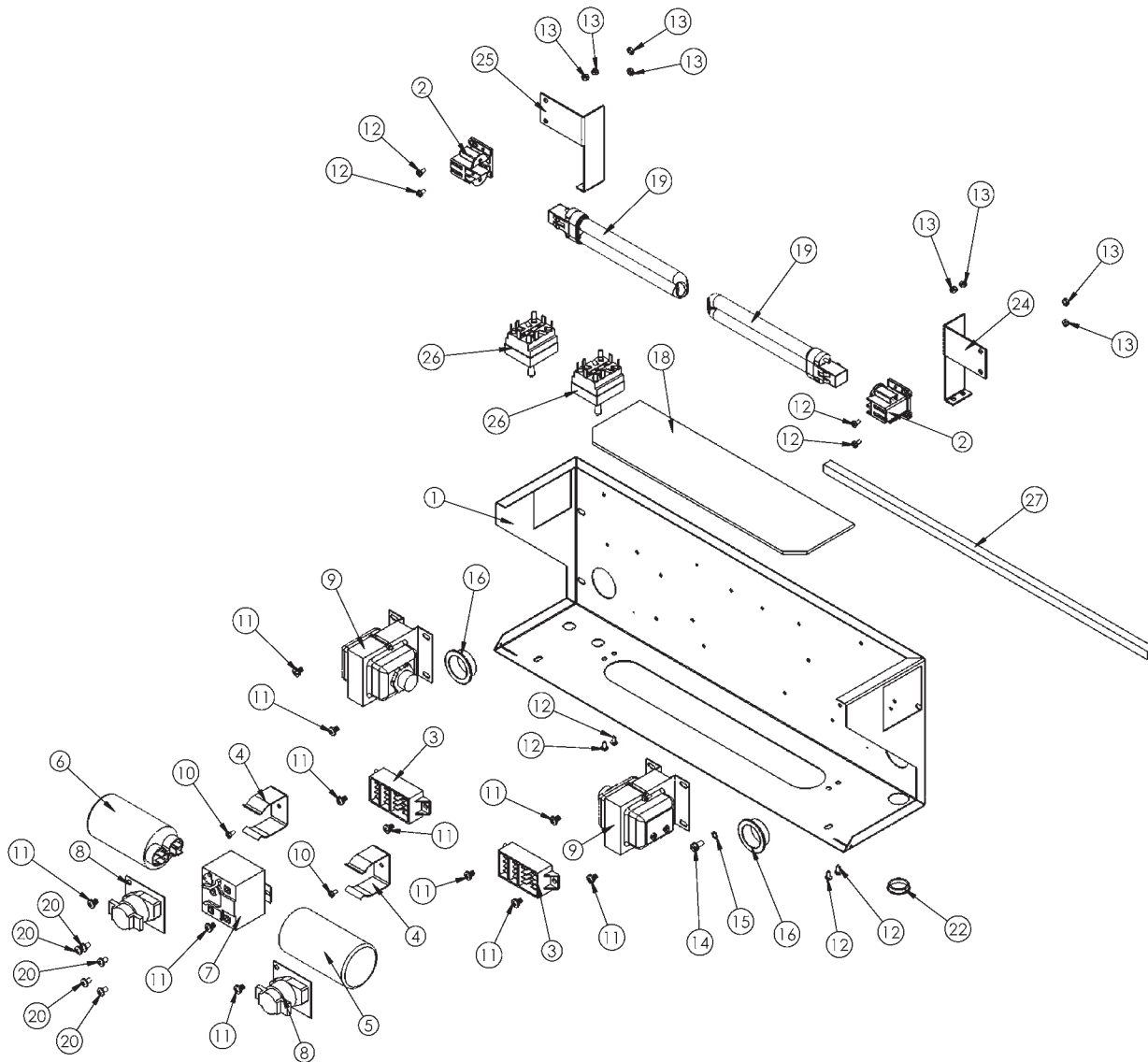


Item	Part No.	Description	Item	Part No.	Description
1	W0210075	Base Pan Assy 3312	13	W0200800	Suction Line
2	W0211210	Frame Assy	14	W0200801	Comp/Tee Hot Gas Line
3	W0200132	Compressor, 240/220V, 50Hz	15	W0200802	Evap/Tee Hot Gas Line
4	W0200807	Condenser Assy, 3312	16	W0200803	Low Side Process Tube
5	W0321040	Fan Assy, 115V	17	W0200804	High Side Process Tube
6	W0321023	Motor Assy, 1/4 HP	18	W0200805	Comp/Access Valve Line
7	W0611410	Rivet, Magna Lok	19	W0620106	Tee, 1/2 x 3/8 x 3/8 Copper
8	W0611247	1/4\" Int. Tooth Lockwasher	20	W0620108	Tee, 3/8 x 3/8 x 1/4
9	W0611082	Nut, 5/16-28 Flange, Lg	21	W0620112	Elbow, 3/8\"OD x 3/8\"OD x 3/8\"OD
10	W0611074	Nut, Hex 1/4-20, Z/P	22	W0620114	Tee, 3/8\" ODS Copper
11	W0200412	Spacer, Compressor	23	W0650501	Valve, Access 1/4 Extended End
12	W0200413	Compressor Mount Grommet			

# Model 3312

## Electrical Box Assembly

### 115V Air-Cooled Model

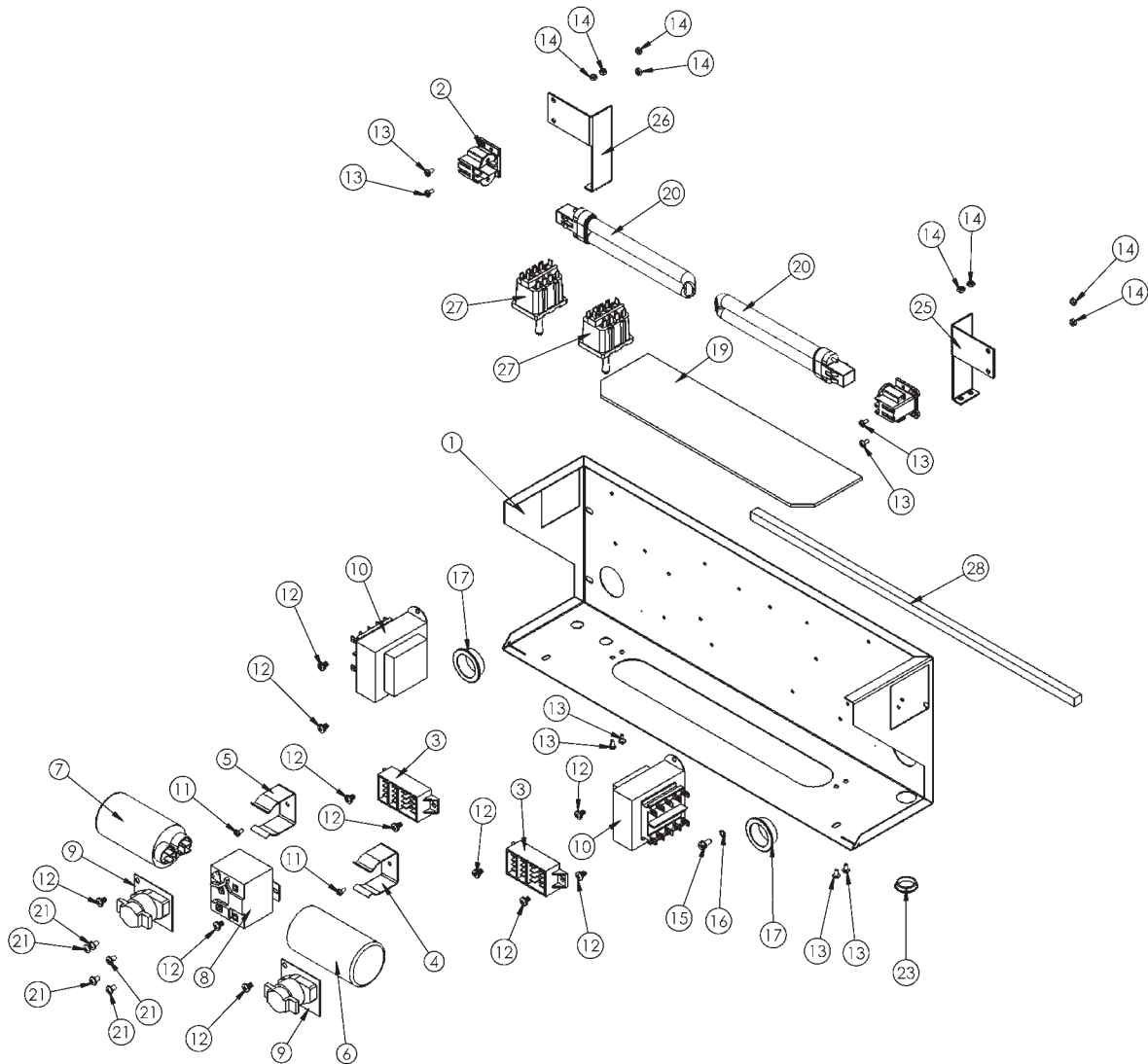


Item	Part No.	Description	Item	Part No.	Description
1	W0572297	Electrical Box, 3312	15	83151	Washer, Lock, #8, Ext. Tooth
2	W0570044	Socket, Light-Leviton	16	W0630006	Heyco Snap Bushing
3	W0570235	Terminal, Block, 4 Circuit	17	86600	Tie, Wire, Nylon, T18R
4	W0630811	Clip, Capacitor-Small	18	W0631619	Electrical Box Lens, 3312
5	W0570603	Start Capacitor	19	W0570043	Bulb, Fluorescent
6	W0570617	Capacitor, Run	20	W0610132	8-32 x 1/4" Screw
7	W0570638	Relay, Compressor	21	W0571002	Wire Harness
8	W0570651	Heat Sequencer	22	101126	Heyco Shorty Plug
9	W0572032	Transformer Sub-Assy	23	W0572192	Mix Low Sub-Assy
10	83248	6-32 x 1/4 Screw	24	W0572306	R.H. Light Bracket, 3312
11	W0610131	Screw, #8x3/8 PH PN T/B ZNC/GN	25	W0572305	L.H. Light Bracket, 3312
12	W0610015	6-32 x 1/4 Screw	26	W0570912	Toggle Switch
13	86827	6-32 Hex Nut	27	101127	Seal, Electrical Box Twin
14	0076	8-32 x 3/8 Hex Head Ground Screw			

# Model 3312

## Electrical Box Assembly

### 220V Air-Cooled Model

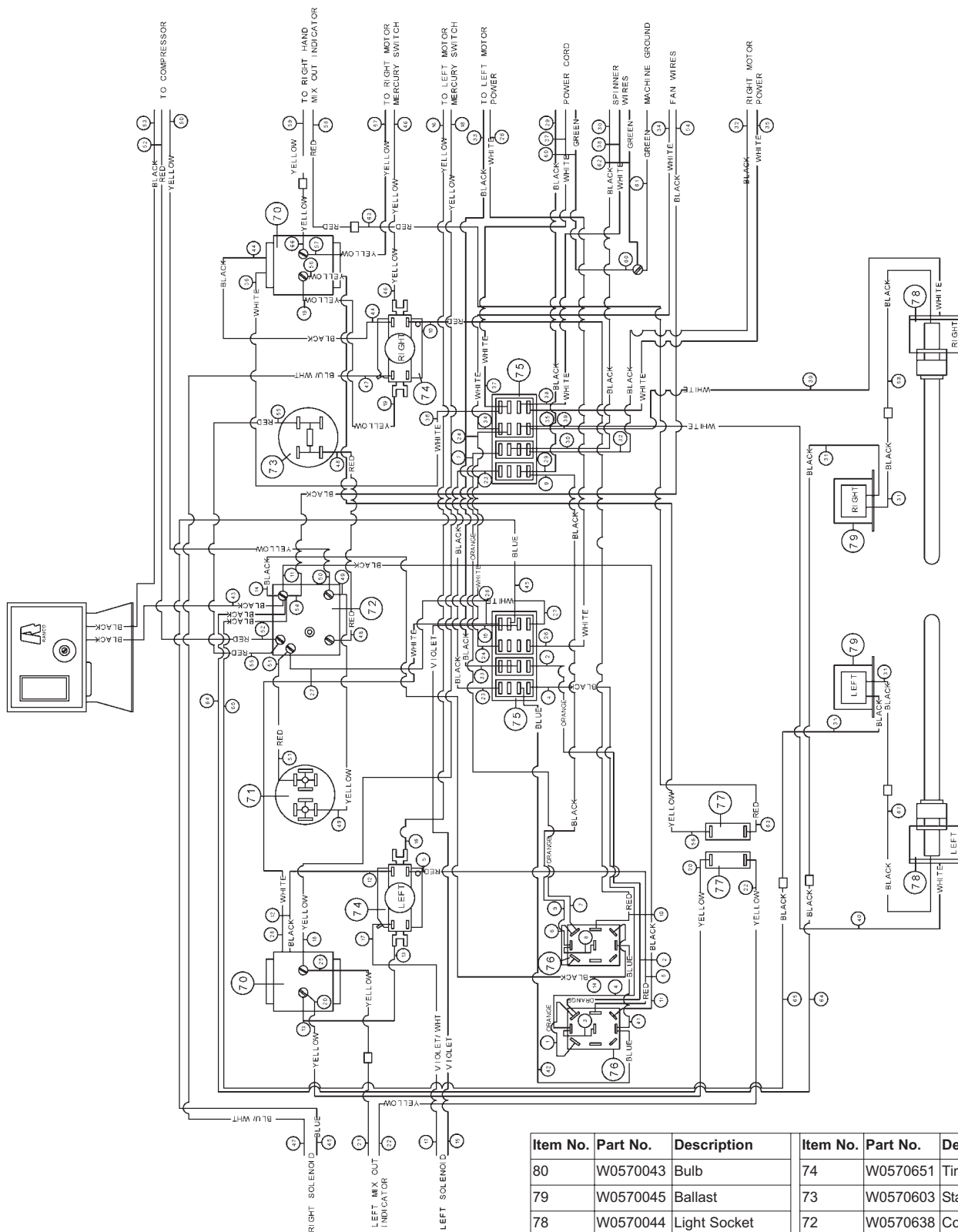


Item	Part No.	Description	Item	Part No.	Description
1	W0572297	Electrical Box, 3312	15	0076	8-32 x 3/8 Hex Head Ground Screw
2	W0570054	Socket, Light-Leviton	16	83151	Washer, Lock, #8, Ext. Tooth
3	W0570235	Terminal, Block, 4 Circuit	17	W0630006	Heyco Snap Bushing
4	W0630812	Clip, Capacitor-Large	18	86600	Tie, Wire, Nylon, T18R
5	W0630811	Clip, Capacitor-Small	19	W0631619	Electrical Box Lens, 3312
6	W0570666	Start Capacitor	20	W0570055	Bulb, Fluorescent
7	W0570667	Capacitor, Run	21	W0610132	8-32 x 1/4" Screw
8	W0570876	Relay, Compressor	22	W0572527	Wire Harness
9	W0570651	Heat Sequencer	23	101126	Heyco Shorty Plug
10	W0570871	Transformer Sub-Assy	24	W0572192	Mix Low Sub-Assy
11	83248	6-32 x 1/4 Screw	25	W0572306	R.H. Light Bracket, 3312
12	W0610131	Screw, #8x3/8 PH PN T/B ZNC/GN	26	W0572305	L.H. Light Bracket, 3312
13	W0610015	6-32 x 1/4 Screw	27	W0570940	Toggle Switch
14	86827	6-32 Hex Nut	28	101127	Seal, Electrical Box Twin

# Model 3312

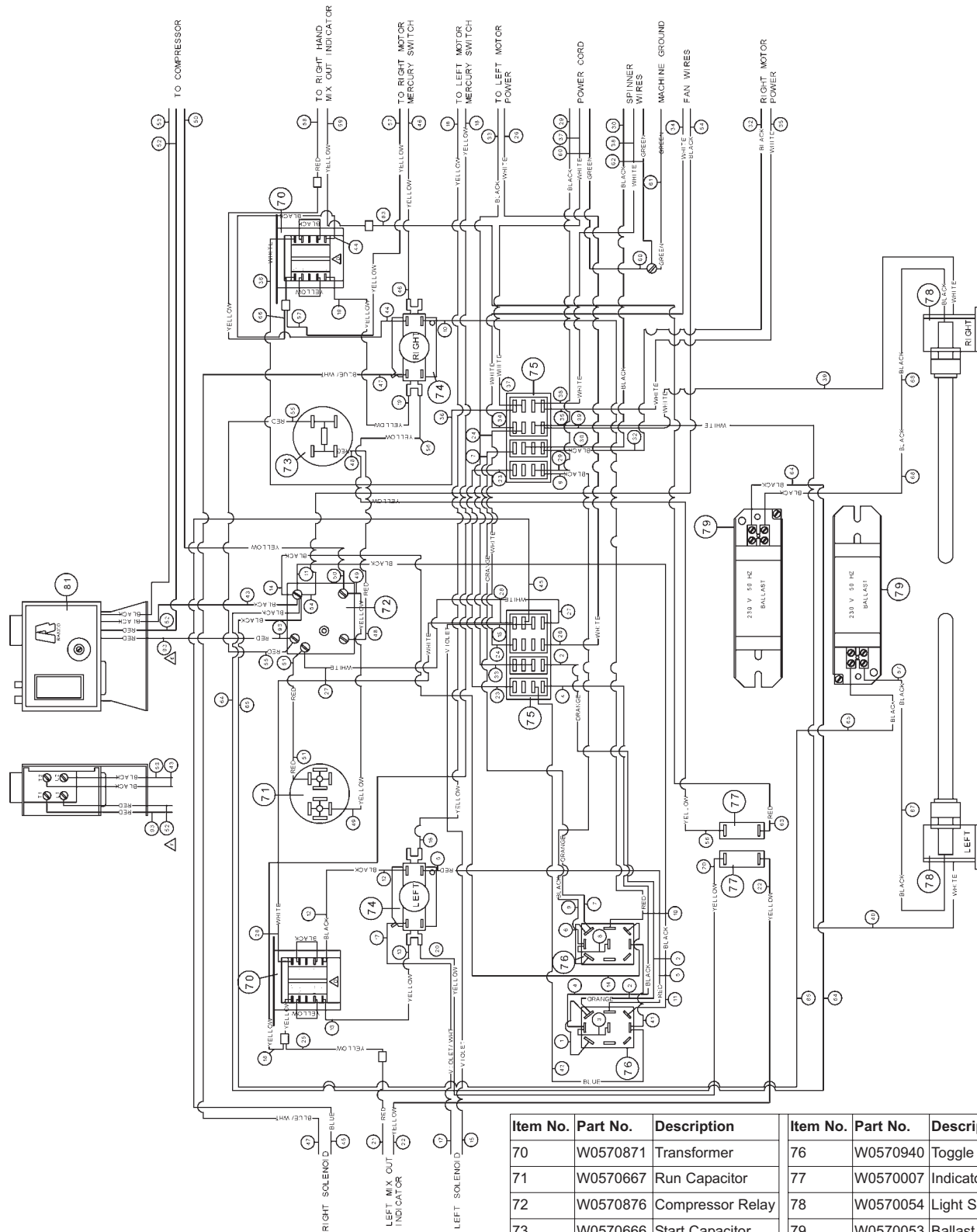
## Wiring Diagram

### 115V Air-Cooled Model



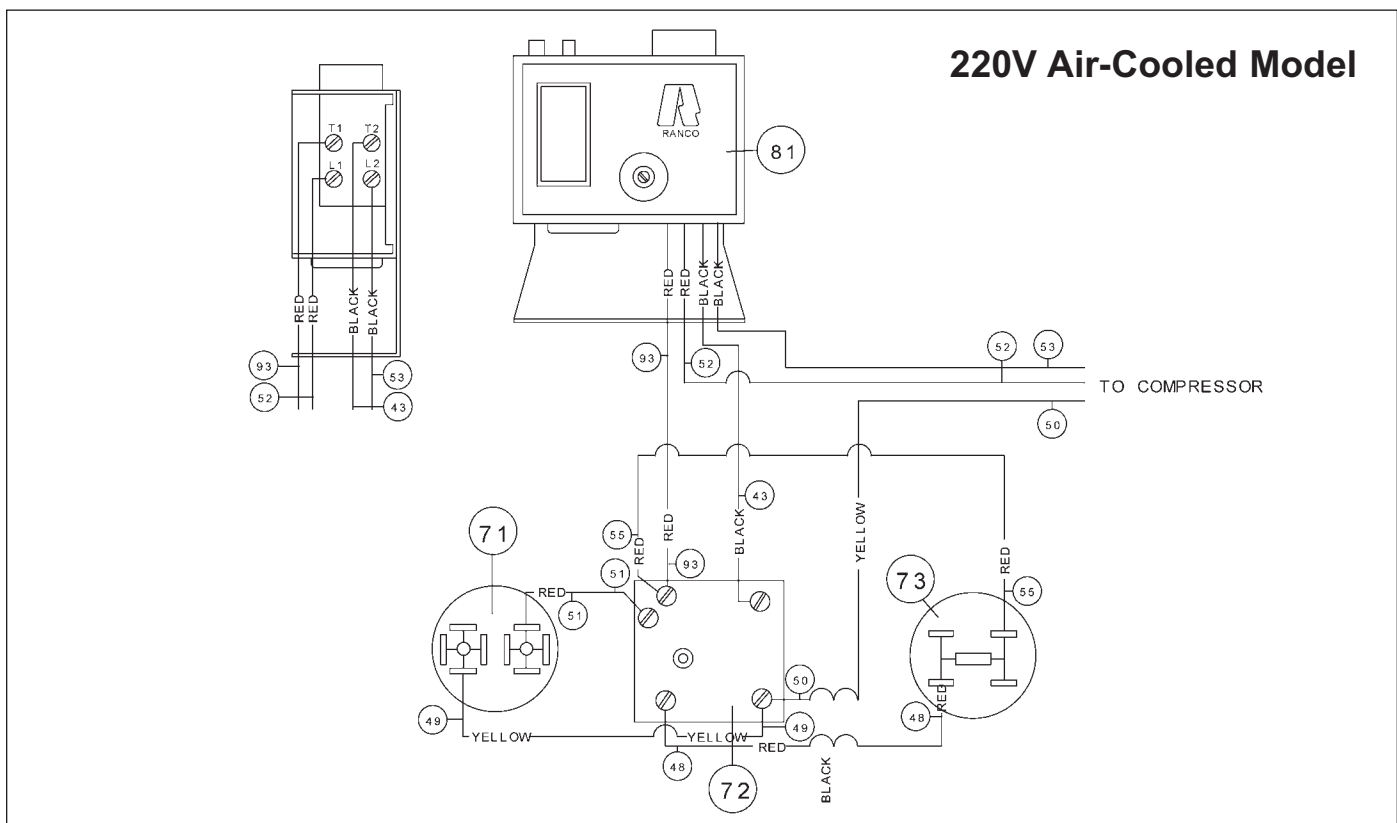
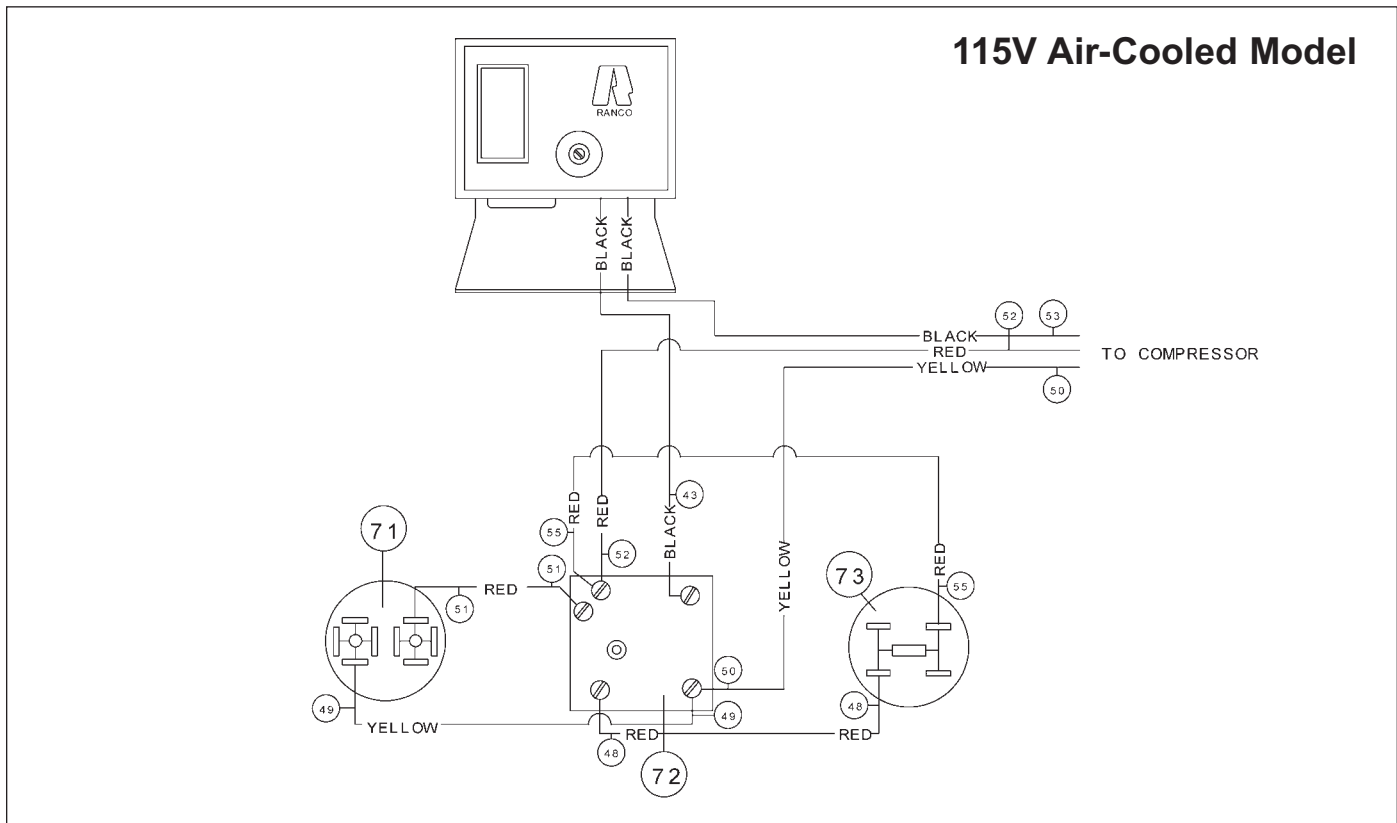
Item No.	Part No.	Description	Item No.	Part No.	Description
80	W0570043	Bulb	74	W0570651	Time Delay Relay
79	W0570045	Ballast	73	W0570603	Start Capacitor
78	W0570044	Light Socket	72	W0570638	Compressor Relay
77	W0570007	Indicator Light	71	W0570617	Run Capacitor
76	W0570912	Switch	70	W0572032	Transformer
75	W0570235	Terminal Block			

# Model 3312 Wiring Diagram 220V Air-Cooled Model



Item No.	Part No.	Description	Item No.	Part No.	Description
70	W0570871	Transformer	76	W0570940	Toggle Switch
71	W0570667	Run Capacitor	77	W0570007	Indicator Light
72	W0570876	Compressor Relay	78	W0570054	Light Socket
73	W0570666	Start Capacitor	79	W0570053	Ballast
74	W0570651	Time Delay Relay	80	W0570055	Bulb
75	W0570235	Terminal Block	81	W0650427	Ranco Controller

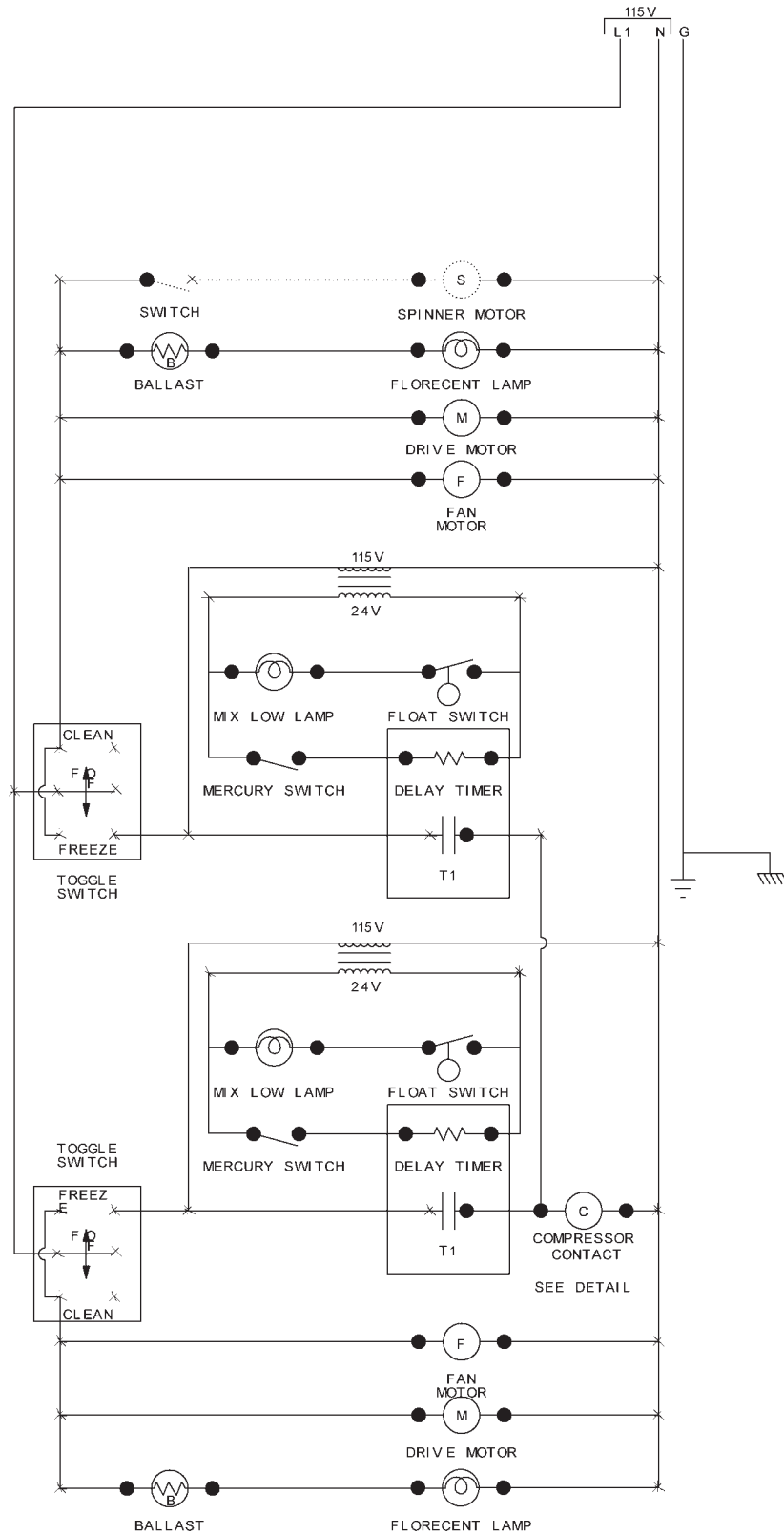
# Model 3312 Compressor Wiring



# Model 3312

## Ladder Diagram

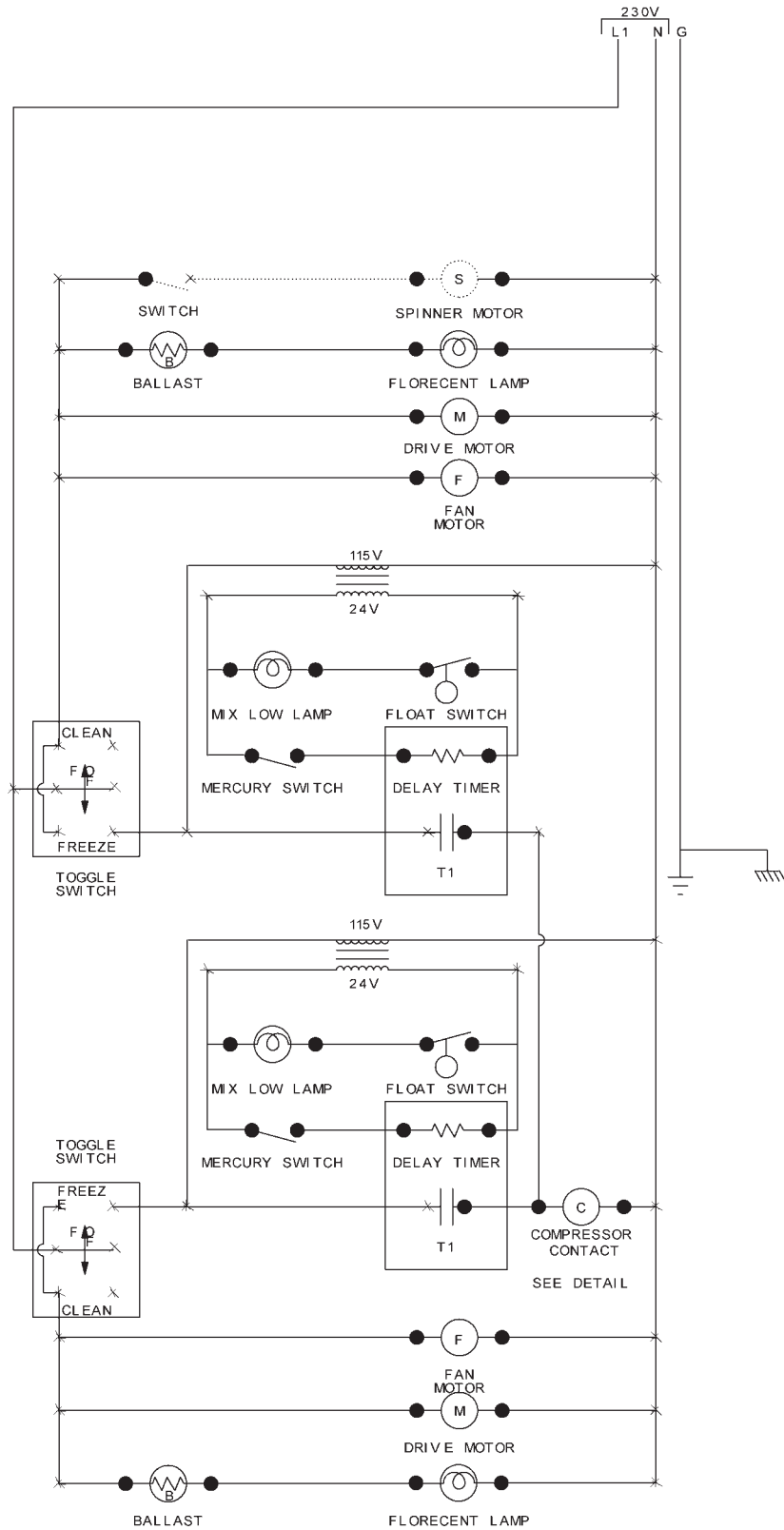
### 115V Air-Cooled Model



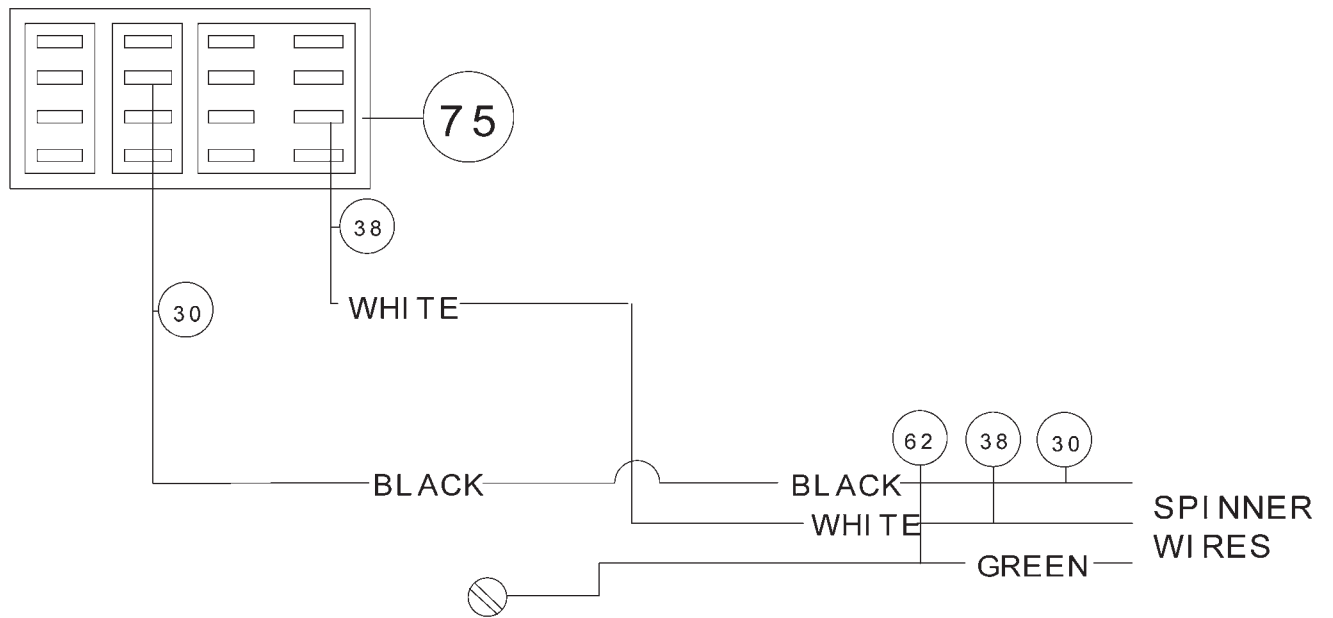
# Model 3312

## Ladder Diagram

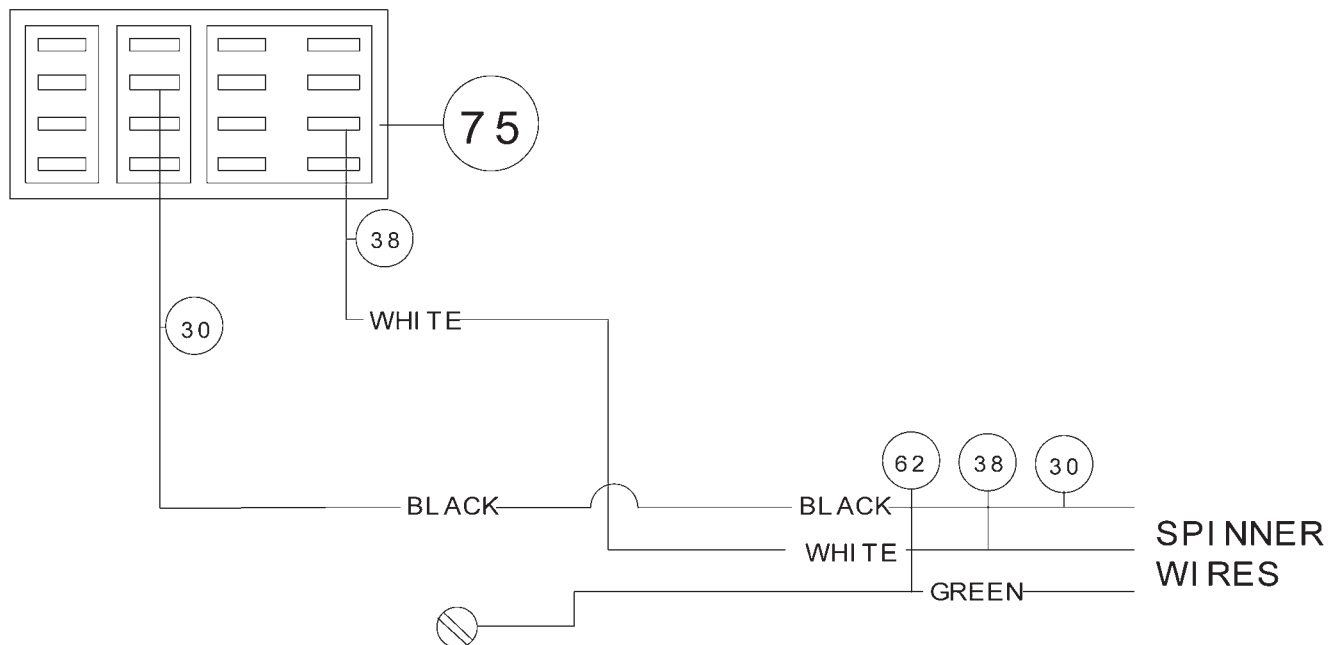
### 220V Air-Cooled Model



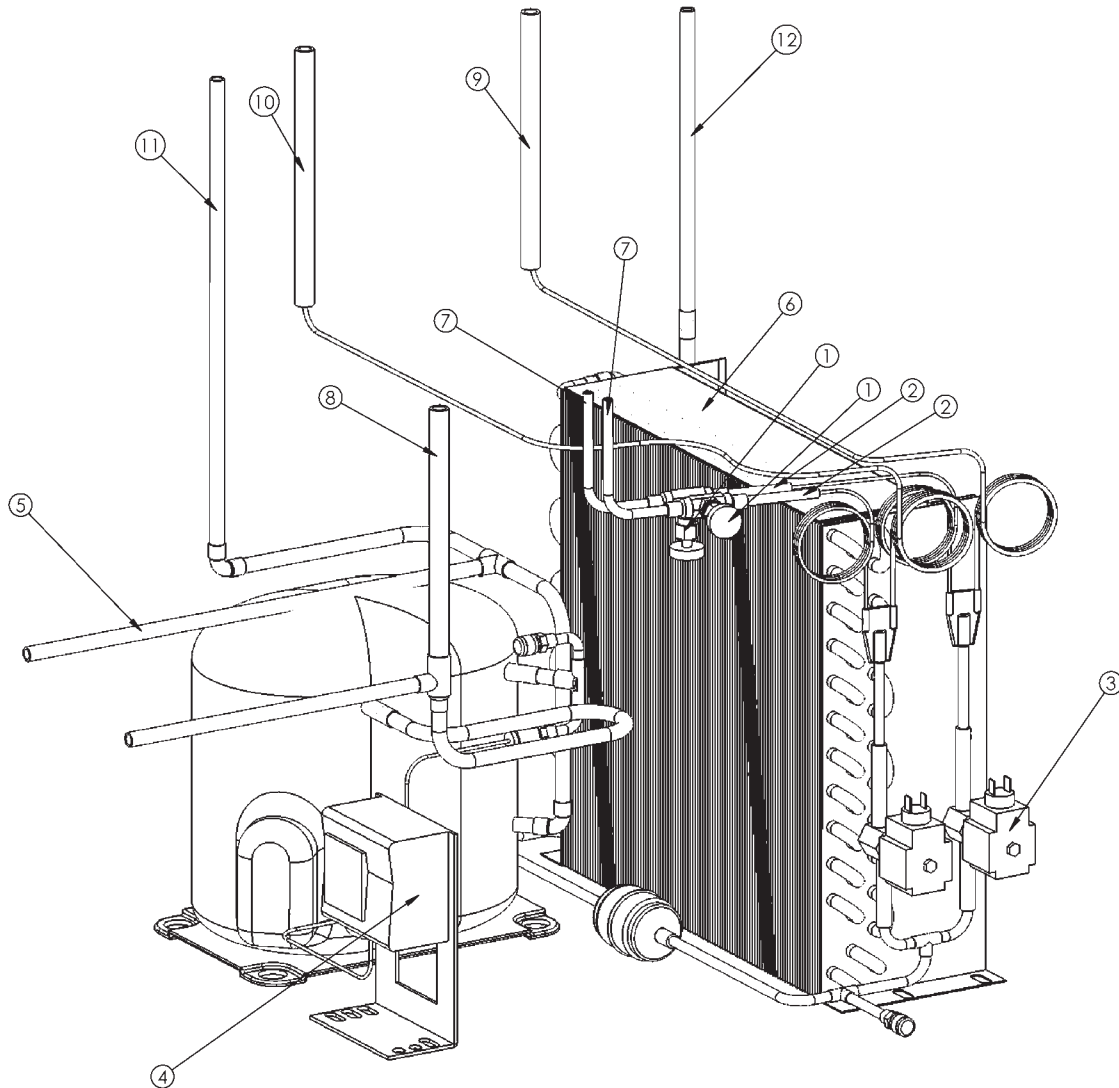
# Model 3312 (AC Units) Spinner Hook-Up 115V Model



# Model 3312 Spinner Hook-Up 220V Model

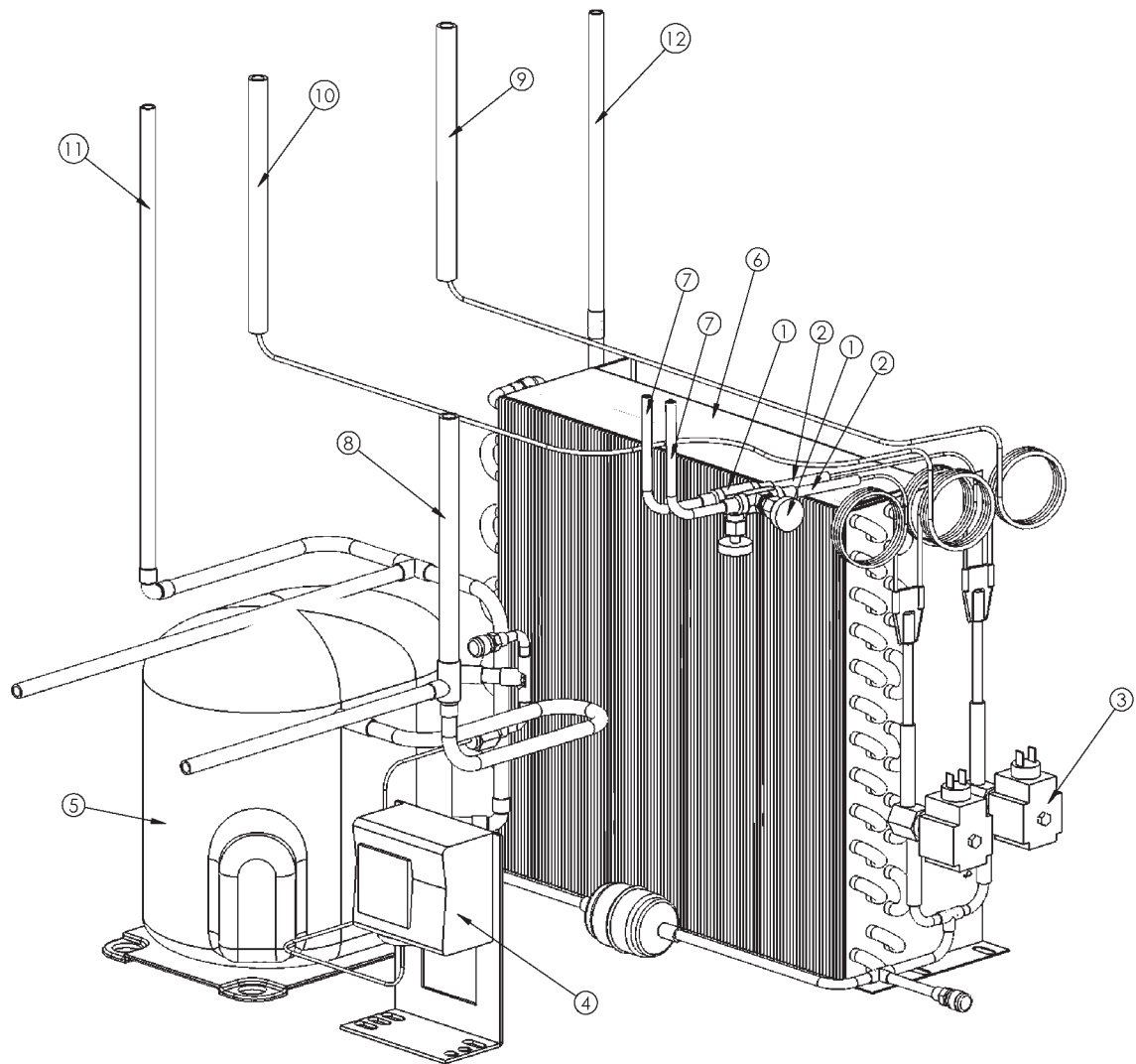


**Model 3312  
Refrigeration  
115V Air-Cooled Model**



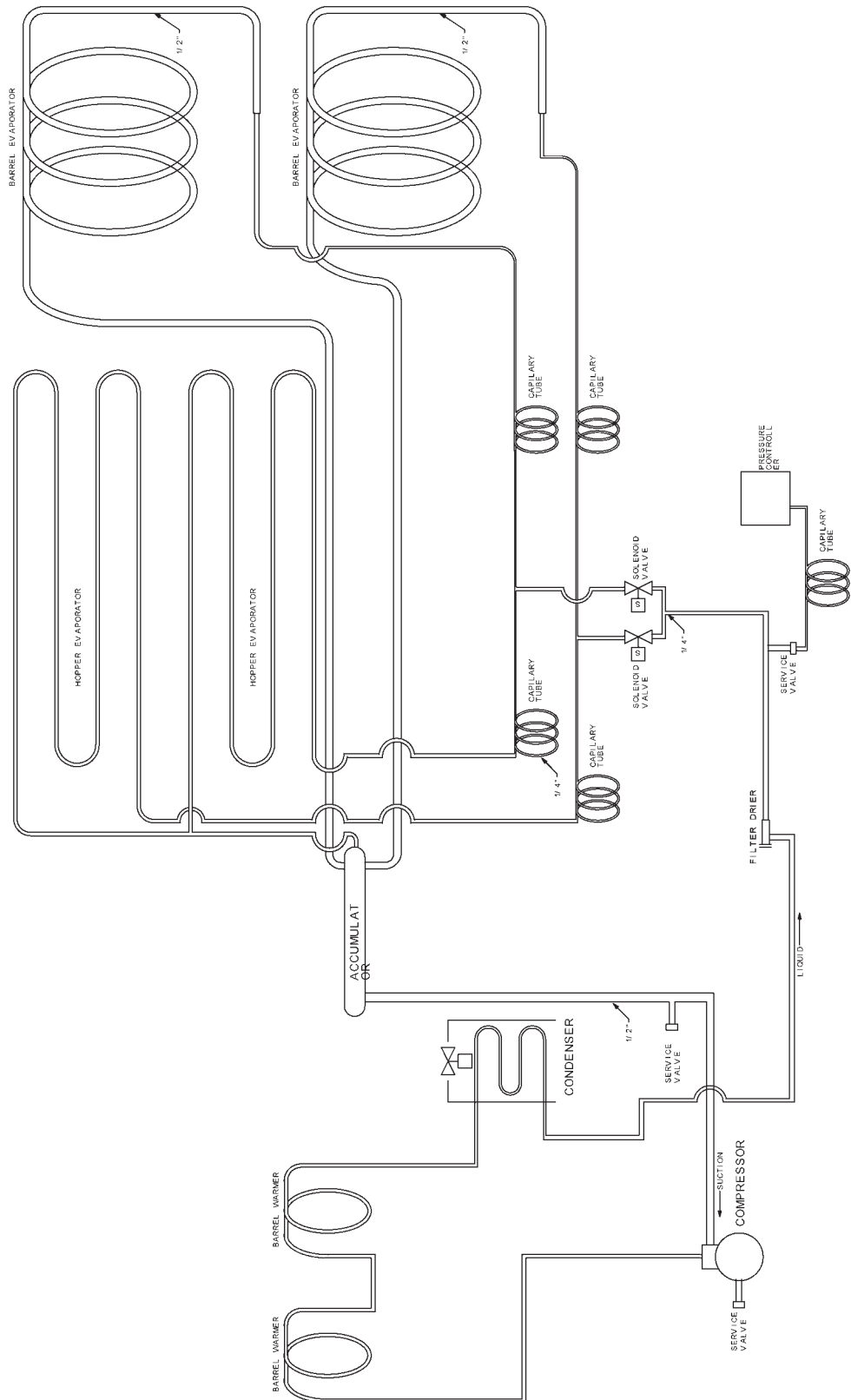
ITEM NO.	PART NO.	DESCRIPTION
1	W0650416	Valve, Needle, 1/4" Fem. Sweat
2	W0201319	NEEDLE VALVE/CAPILLARY LINE
3	W0200808Ref	Solenoid/Drier Assembly, 3312
4	W0650414Ref	Low Pressure Controller
5	W0200806	Compressor Assembly, 3312, 115V
6	W0200807	Condenser Assembly, 3312
7	Hopper Coolant Lines	Hopper Coolant Lines
8	Accumulator Line	Accumulator Line
9	Left freezing Cyl. Line	Left Freezing Cly. Line
10	Right Freezing Cyl. Line	Right Freezing Cly. Line
11	Hot Gas Line 1	Hot Gas Line 1
12	Hot Gas Line 2	Hot Gas Line 2

# Model 3312 Refrigeration 220V Air-Cooled Model



ITEM NO.	PART NO.	DESCRIPTION
1	W0650416	Valve, Needle, 1/4" Fem. Sweat
2	W0201319	NEEDLE VALVE/CAPILLARY LINE
3	3312 220V Solenoid Assy	Solenoid/Drier Assembly, 3312
4	W0650427Ref	Low Pressure Controller
5	3312 220 Volt 50 Hz. Compressor	Base Assembly
6	W0200807	Condenser Assembly, 3312
7	Hopper Coolant Lines	Hopper Coolant Lines
8	Accumulator Line	Accumulator Line
9	Left freezing Cyl. Line	Left Freezing Cly. Line
10	Right Freezing Cyl. Line	Right Freezing Cyl. Line
11	Hot Gas Line 1	Hot Gas Line 1
12	Hot Gas Line 2	Hot Gas Line 2

# Model 3312 Refrigeration Schematic (AC Units) 115V & 220V Models





[WWW.MargaritaMachineParts.Net](http://WWW.MargaritaMachineParts.Net)



**GRINDMASTER<sup>®</sup>**  
CORPORATION

---

Grindmaster<sup>®</sup> Coffee Grinders and Brewers • Espresso<sup>®</sup> Espresso Machines • Crathco<sup>®</sup> Hot Beverage Dispensers  
Crathco<sup>®</sup> Cold and Frozen Beverage Dispensers • American Metal Ware<sup>®</sup> Coffee and Tea Systems

972-276-2757 Fax 927-423-9993